

# REZNOR®



## APPLICATIONS Space Heating

- » WAREHOUSES
- » FACTORIES
- » GREENHOUSES
- » COMMERCIAL
- » INDUSTRIAL
- » GYMNASIUMS
- » RESIDENTIAL GARAGES
- » RETAIL

# UNIT HEATERS



### Capacities



30 - 1,200 MBH



380 - 16,750 CFM



2 - 60 kW



13 - 350 MBH

[ReznorHVAC.com](http://ReznorHVAC.com)

# A Variety of Unit Heaters for any Need

We are the world's largest manufacturer of commercial unit heaters. You'll find no better selection. Here are some of the benefits from choosing Reznor unit heaters.

- **Easy installation**
  - » Compact - minimal space required
  - » Zone heating - direct heating where you need it
  - » Wide range - many sizes and types from which to choose
- **Money saving operation**
  - » Energy efficient
- **Aesthetically pleasing**
  - » Industrial strength with showroom appearance



## SELECTION GUIDE

Model	Gas Fired Unit Heaters					Specialty Unit Heaters				
	GOOD		BETTER		BEST	Gas	Hydronic	Oil	Electric	
	UDAP	UDBP	UDAS	UDBS	UEAS	LDAP	WS	OH	EGHB	EXUB
<b>Fuel Efficiency</b>	Up to 83%	Up to 83%	Up to 83%	Up to 83%	Up to 93%	83%		82%		
<b>Axial Propeller Fan</b>	✓		✓		✓	✓	✓		✓	✓
<b>Ductable Blower</b>		✓		✓						
<b>Power Vented</b>	✓	✓	✓	✓	✓	✓		✓		
<b>Separated Combustion</b>			✓	✓	✓					
<b>Heating Technology</b>	T <sub>CORE</sub> <sup>20</sup>	T <sub>CORE</sub> <sup>2</sup>	T <sub>CORE</sub> <sup>2</sup>	T <sub>CORE</sub> <sup>2</sup>	T <sub>CORE</sub> <sup>30</sup>	T <sub>CORE</sub> <sup>2</sup>	Fin Tube	Drum	Encased Element	
<b>Heating Range (MBH)<sup>A</sup></b>	30-400	30-400	30-400	30-400	130-310	400-1,200	18-350	118-229	2-60 <sup>A</sup>	5-30 <sup>A</sup>
<b>CFM Range</b>	450-5,125	450-5,125	500-6,200	500-6,200	2,250-4,275	3,250-16,750	270-4,750	2,000-3,200	700-2,000	400-3,000

<sup>A</sup> Heating range shown in MBH except for Models EGHB and EXUB. These heating values are shown in kW.

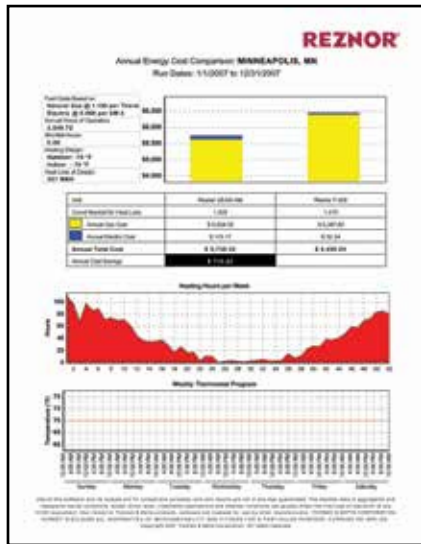

### Take the Reznor Challenge:

Use our Energy Analyzer Software to compare Reznor unit heaters to others. Prove to yourself that real value is determined by looking at the complete energy efficiency (both thermal and electrical).



## A Heritage of Providing Comfort

In 1937 the first Reznor self-contained, suspended, gas-fired unit heater was introduced.

This technological advancement was the result of years of innovation dating back to the introduction of the first Reznor gas stove heater in 1888.

This innovation and advancement continues in Reznor unit heaters today, and can be seen in our complete line of units, including the super high efficiency unit heater, and the high bay heater.

# Super High Efficiency Unit Heater



Model UEAS

Don't be misled by imitators. We introduced the first high efficiency unit heater in the world more than 25 years before any other manufacturer. Since 1983, our aluminum secondary heat exchanger technology has proven itself with worry-free operation.

Model UEAS (2nd generation) unit heaters have a refreshing appearance with a clean, glossy white cabinet finish.

- **Best in Class**
  - » Up to 93% gas fuel efficiency
  - » Lowest electrical usage
- **Technologically Advanced Heat Exchanger**
  - » Stainless steel primary heat exchanger
  - » High-performance aluminum alloy MacroChannel® secondary heat exchanger (patent pending)
- **Compact** - 40% smaller than previous generation heater
- **Visually Pleasing** - Attractive formed and finished cabinet - doesn't look like an industrial unit heater
- **Versatile**
  - » Shipped for natural gas with propane conversion kit
  - » Vertical or horizontal venting
  - » Available for 60 Hz or 50 Hz operation
- **Dependable** - Backed by a limited 10 year heat exchanger and 5 year parts warranty
- **Consistent Quality** - Reznor has been a leader in the HVAC industry since 1888
- **Ease of Maintenance** - Easy access and easy cleaning



## TECHNICAL DATA

Model UEAS	130	180	260	310
Input Heating Capacity (BTUH)	131,000	175,000	260,000	305,000
Thermal Efficiency (%)	93	91	92	91
Discharge Air Temperature Rise (°F)	50	60	50	60
Air Volume (CFM)	2,256	2,458	4,430	4,283
Electrical/Control	115V/24V			
Power Consumption (watts at 115V)	657	657	1,020	1,020

## The Advantages of MacroChannel®

The smooth aerodynamic design of the Reznor MacroChannel allows more air through the heater and down to the floor where you need it.

Another advantage is the MacroChannel will not collect dust, lint, or debris like a traditional "coil" style secondary heat exchanger.

When you combine the fuel efficiency with the electrical motor efficiency, Reznor units cost less to operate than other comparable heaters.



# High Efficiency Unit Heaters



Models UDAP & UDAS

The V3 series is our most popular style of unit heater.

These units are sturdy enough to provide reliable heat in demanding commercial/industrial buildings. They are also equally at home in residential garages or workshops<sup>A</sup>.

The preeminent feature is the aerodynamic T<sub>CORE</sub><sup>2</sup> heat exchanger and single burner combustion system.

- **Saves Money** - 82-83% thermal efficiency
- **Allows Maximum Headroom** - The low profile and ability to be mounted close to the ceiling leaves plenty of headroom.
- **Reliable** - Patented<sup>B</sup> T<sub>CORE</sub><sup>2</sup> single burner combustion system
- **Quiet** - Isolated fan and venter motors
- **Compact** - Control compartment houses all electrical components
- **Direct Heat Where It's Needed**
  - » Vertical and horizontal louvers
  - » Downturn nozzles



## TECHNICAL DATA

Models UDAP/UDAS/UDBP/UDBS	30	45	60	75	100	125	150	175	200	225	250	300	350	400	
Input Heating Capacity (MBH)	30	45	60	75	105	120	150	175	200	225	250	300	350	400	
Thermal Efficiency (%)	82	83	83	83	83	83	83	83	83	83	83	83	83	83	
Discharge Air Temperature Rise (°F)	UDAP/UDAS	50	55	60	60	60	60	60	60	60	60	60	60	60	
	UDBP/UDBS	75	75	75	75	75	75	75	75	75	75	75	75	80	
Air Volume (CFM)	UDAP/UDAS	456	629	769	961	1,345	1,537	1,921	2,242	2,562	2,882	3,202	3,843	4,483	5,123
	UDBP/UDBS	506	759	1,012	1,265	1,793	2,049	2,562	2,989	3,416	3,843	4,270	5,123	5,977	6,185

<sup>A</sup> Model UDAP and UDAS in sizes 30-125 are approved for installation in attached residential garages/workshops under CSA International Requirement 10.96 - U.S. and CR96-0005 - Canada.

<sup>B</sup> U.S. Patent No. 6,889,686



Models UDBP & UDBS



## The Advantage of Reznor Separated Combustion

Reznor separated combustion system technology eliminates common "open flame" combustion problems such as contaminants in the indoor air, and negative building air pressure.

- ▶ Air for combustion is taken from outside the building, preventing dirt, lint, dust or other contaminants in the indoor atmosphere from being burned.
- ▶ The combustion air flow is unaffected by negative building pressure or wind which can cause nuisance shutdown.
- ▶ Only one building penetration, horizontal or vertical (see the illustration at right).

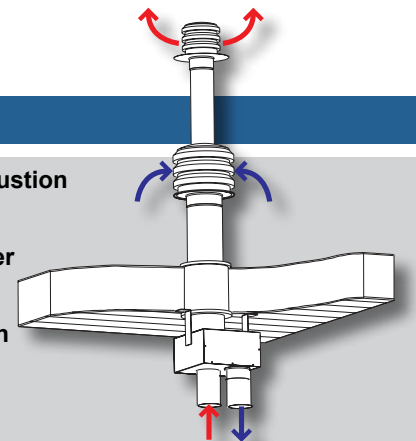



# High Capacity, High Bay Heater

## Downflow air discharge, high velocity heater for high bay applications

Model LDAP can provide more heat than a standard unit heater, up to 1,200,000 BTUH. This is the same amount of heat as a typical packaged heater or direct fired unit.

Model LDAP is less expensive to install than a direct or indirect fired, packaged heating system.

De-stratification feature sends “recycled” heat back to the floor (see below).

- **Saves Money**
  - » 83% Thermal efficiency
  - » De-stratification adjustable fan control (air economizer)
  - » Single point connections for gas, electricity and vent
- **Sturdy** - Patented<sup>B</sup> T<sub>CORE</sub><sup>2</sup> single burner combustion system
- **Dependable** - Titanium stabilized heat exchanger(s)
- **Quiet** - Vibration/noise isolated fan and venter motors
- **Versatile**
  - » Natural gas or propane
  - » Wall or ceiling mounting
  - » Run the fans without the heat in summer to improve working conditions by alleviating stagnant air to create a cooling affect
  - » Directional nozzles and louvers aim the heated air right where you need it (see photo below)



Model LDAP

Model LDAP is arranged for vertical (downflow) air delivery. As George Reznor once said, “We live on the floor, not on the ceiling.”



## TECHNICAL DATA

Model LDAP	400	800	1200
Input Heating Capacity (BTUH)	400,000	800,000	1,200,000
Thermal Efficiency (%)	83	83	83
Air Volume (CFM)	5,589	11,178	16,768
Air Volume (CFM) - De-stratification @ Medium Speed	4,650	9,300	13,950
Air Volume (CFM) - De-stratification @ Low Speed	3,250	6,500	9,750



<sup>B</sup> U.S. Patent No. 6,889,686

## Provide “Recycled” Heat to the Work Area

Step 1: Wall mounted thermostat calls for heat.

Step 2: Burners and high speed fans direct heating to the floor.

Step 3: Thermostat setting is reached, shutting off heater. Heated air naturally rises.

Step 4: Unit mounted sensor triggers the low speed fans to return heat to the floor.

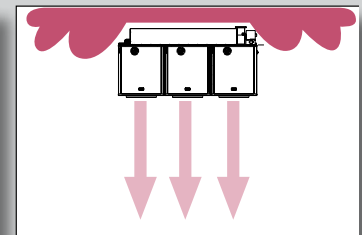
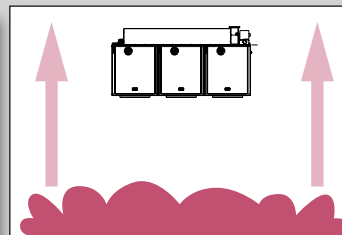
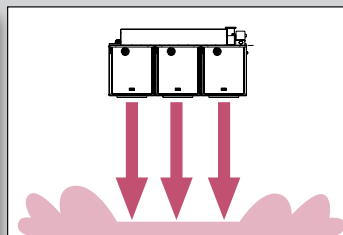
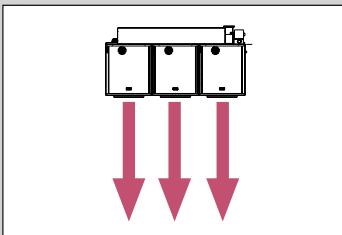

# Hydronic Heating

If you need hydronic (steam or hot water) heating, Reznor Model WS is the heater of choice.

- **Versatile**
  - » Each unit can be mounted for horizontal or vertical (down) air delivery
  - » Units can be selected to operate at 60 Hz or 50 Hz
  - » Accurate size selection can be determined by using Reznor selection software program
- **Dependable** - The standard totally enclosed motors have internal overload protection
- **Adjustable** - Every motor can be field set for high speed/low speed
  - » High speed for expanded floor coverage
  - » Low speed for higher temperature rise
- **Sturdy** - The heat exchanger of every unit is pressure tested at the factory
- **Quiet** - Fans are mounted with vibration isolation for smooth operation



Model WS



## TECHNICAL DATA

Model WS			18/24	23/33	44/62	60/85	78/110	96/120	140/175	190/238	300/350
Maximum Heating Capacity (MBH)	Fan Speed	Low	18	23	44	60	78	96	140	190	300
		High	24	33	62	85	110	120	175	238	350
Maximum Leaving Air Temperature °F		Low	121°	124°	132°	129°	125°	134°	134°	140°	133°
		High	115°	121°	126°	123°	121°	131°	130°	137°	128°
Noise Level at 16-1/2 ft (5m) - dB(A)		Low	45	46	49	54	57	47	49	52	61
		High	52	54	58	63	65	52	55	60	67
Approximate Air Volume CFM		Low	270	330	560	800	1,100	1,200	1,750	2,200	3,800
		High	400	500	860	1,250	1,650	1,550	2,300	2,850	4,750
Electrical Power			115/1/60 - 240/1/50 (50 Hz available on request)								
Working Pressure			Hot Water - 150 psi; Steam - 145 psi								

## Increased Air Throw Capacity

The Air Flow Induction Optimizer increases the throw for Reznor Models WS. This increased flow results in energy savings and better environmental control. The unique shape of the deflecting louvers which create layers of hot air at the unit outlet. The space created between layers causes air around the front of the unit to be drawn into the air stream and mixed with the heated air. The result is a significant increase in the air throw.

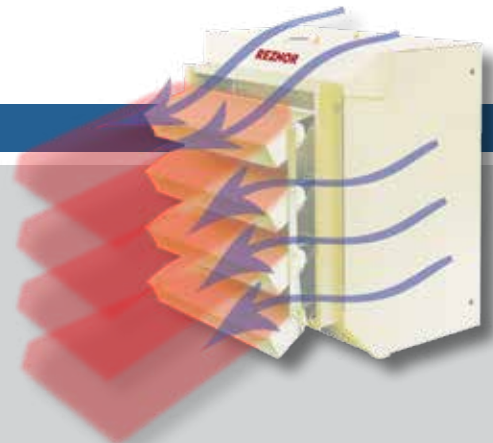

# Other Unit Heaters

## Oil-Fired Unit Heaters

Reznor fuel oil fired heaters are ideal for locations where heating fuel oil is preferred. Model OH units are 81% fuel efficient.

All units feature a robust heat exchanger combustion chamber with large, easily accessible, service panels. The oil burner assembly has an integral fuel pump and a pressure-atomizing flame-retention burner that provides long life for the combustion chamber. The burner has an electronic spark ignition system.

### TECHNICAL DATA

Model OH	95	140	190
Thermal Input (BTUH) <sup>A</sup>	119,000	175,000	231,000
Thermal Output (BTUH)	96,000	142,000	187,000
Air Volume (Free Air) (CFM)	2,000	3,200	3,200

<sup>A</sup> Input based on 140,000 BTUs per gallon of fuel oil.



Model OH



## Electric Unit Heaters

When natural gas, propane and hydronic heating are not available, choose a Reznor electric unit heater.

A variety of unit-mounted or wall mounted thermostats are available.

- **Attractive Appearance** - Epoxy/polyester powder paint finish
- **Durable** - Heavy gauge cabinet construction
- **Versatile** - A variety of mounting kits are available for field installation



Model EGHB is designed for areas requiring a high level of air flow. This unit heater may be mounted horizontally (wall or ceiling) using supplied brackets or vertically using 4 threaded rods.

### TECHNICAL DATA

Size	2	3	4	5	7	10	15	20	25	30	40	50	60
kW	2	3	4	5	7.5	10	15	20	25	30	40	50	60
CFM	EGHB	700	700	700	700	700	1,350	1,350	1,350	1,350	2,000	2,000	2,000
	EXUB	-	-	-	400	600	800	1,200	1,700	2,100	3,000	-	-

Model EXUB explosion-resistant unit heaters are designed for rugged industrial applications.



Model EXUB

## Other Electric Heaters

There are a variety of Reznor electric unit heaters to fit a variety of needs. These include:

- ▶ Portable unit heaters
- ▶ Architectural cabinet heaters
- ▶ Wall-mounted heaters
- ▶ Ceiling-mounted heaters
- ▶ Wash-down stainless steel heaters





# By Design...

## Aesthetically Pleasing

One of the great things about Reznor unit heaters is that they can be installed anywhere that you need affordable, reliable space heating.

These heaters are robust enough for traditional installations such as warehouses and factories. They are also stylish enough to be installed in retail stores, meeting halls, or other public places.

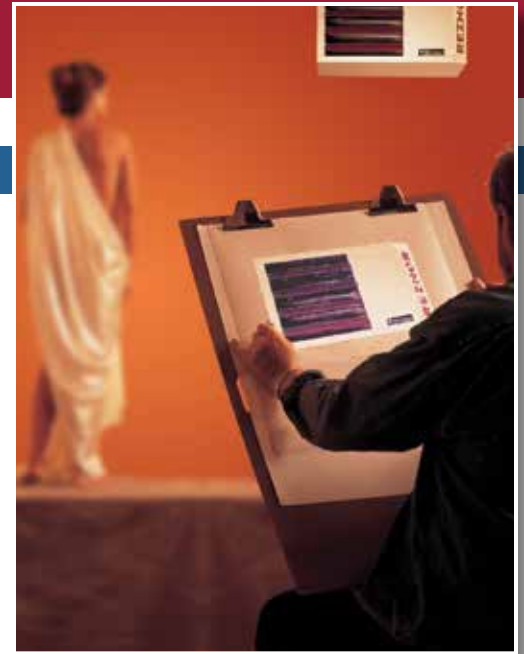

## Energy Efficient

### Model UEAS cuts heating bill by 24%!

At a test site in a Michigan warehouse, two older unit heaters were replaced with new Model UEAS, 90%+ efficient units.

In the spring, the owners reviewed their heating bills from the previous two winters. After comparing the total amount of natural gas used and the weather data (degree days), they calculated that their heating bill was reduced by 23.8%.

## Versatile

Reznor unit heaters are sturdy enough to handle the rigors of demanding commercial/industrial applications, so you'll have no worries applying this to a residential garage or workshop

- ▶ Maintain warm, comfortable working temperature.
- ▶ Store temperature sensitive items for the winter.
- ▶ Stay comfortably warm from home to car.



For complete catalog information including submittals, energy calculations, dimension drawings, and more go to [ReznorHVAC.com](http://ReznorHVAC.com) or call 800-695-1901.

*Note: In keeping with our policy of continuous product improvement, we reserve the right to alter, at any time, the design, construction, dimensions, weights, etc., of equipment information shown here.*

Specifications & illustrations subject to change without notice or incurring obligations.  
O'Fallon, MO (9/17) © Nortek Global HVAC, LLC 2017. All rights reserved.  
Reznor is a registered trademark of Nortek Global HVAC, LLC.  
074F-0917 (Replaces MC-UH-0816)

# REZNOR®