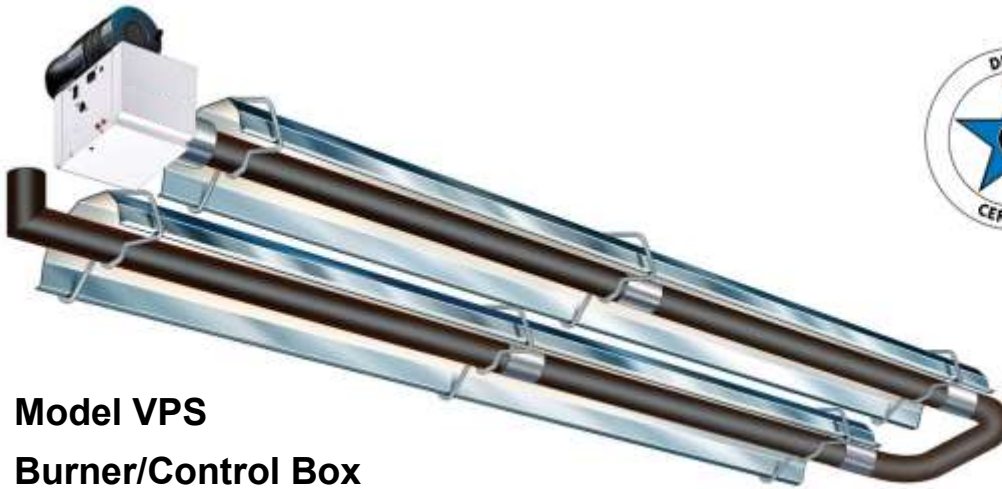


## INSTALLATION / OPERATION / MAINTENANCE

Applies to:

**Model VPS 120V 60Hz  
Gas-Fired, Tubular, Radiant,  
Low-Intensity Infrared Heater  
for generation code BB**



**Model VPS  
Burner/Control Box  
with 20 - 80 ft Tube/Reflector Length**



### FOR YOUR SAFETY

If you smell gas:

1. Open windows.
2. Don't touch electrical switches.
3. Extinguish any open flame.
4. Immediately call your gas supplier.

### FOR YOUR SAFETY

The use and storage of gasoline or other flammable vapors and liquids in open containers in the vicinity of this appliance is hazardous.

**WARNING:** Improper installation, adjustment, alteration, service, or maintenance can cause property damage, injury or death. Read the installation, operation, and maintenance instructions thoroughly before installing or servicing this equipment.

**WARNING:** Gas-fired appliances are not designed for use in hazardous atmospheres containing flammable vapors or combustible dust, in atmospheres containing chlorinated or halogenated hydrocarbons, or in applications with airborne silicone substances.


# Introduction.

Welcome to the new range of powered infra-red heaters. Local regulations may vary and it is the installer's responsibility to ensure that such regulations are satisfied.

All installation, assembly, commissioning and service procedures must be carried out by suitable qualified competent persons and conform with local building codes, or in the absence of local codes, with the National Fuel Gas Code ANSI Z223.1/NFPA 54 or the National Gas and Propane Installation Code CSA B149.1

When assembling, installing, commissioning

and servicing is undertaken on radiant tube heaters specified in these instructions, due care and attention is required to ensure that working at height regulations are adhered to.

 **PLEASE READ** this document prior to installation to familiarize yourself with the components and tools you require at the various stages of assembly.

All Dimensions shown are in inches unless otherwise stated.

**The manufacturer reserves the right to alter specifications without prior notice.**

# Document Index.

## 1 Installation Requirements

- 1.1 Health & Safety
- 1.2 Heater Suspension
- 1.3 Clearance to Combustibles
- 1.4 Gas Connection & Supply Details
- 1.5 Electrical Connections
- 1.6 Ventilation Requirements
  - 1.6.1 Unvented Units
  - 1.6.2 Vented Units
    - 1.6.2.1 Vertical Venting
    - 1.6.2.2 Horizontal Venting
- 1.7 Fresh Air Intake
- 1.8 Technical Details

## 2 Assembly Instructions

- 2.1 Tools Required
- 2.2 Assembly Notes
  - 2.2.1 Emitter Tubes
  - 2.2.2 Turbulator Strips and Burner Inserts
  - 2.2.3 Brackets
  - 2.2.4 Couplers
  - 2.2.5 Reflectors
  - 2.2.6 End Caps (optional)
  - 2.2.7 Bends (where required)
  - 2.2.8 Burner/Fan Assembly

- 2.2.9 Detailed Assembly Drawings

## 3 Start Up Instructions

- 3.1 Tools Required
- 3.2 Start up procedure

## 4 Servicing Instructions

- 4.1 Tools Required
- 4.2 Burner Description
- 4.3 Burner Removal
- 4.4 Burner Gas Injector Servicing
- 4.5 Burner Head and Electrode Servicing
- 4.6 Combustion Fan Assembly
- 4.7 Emitter Tube Servicing
- 4.8 Reflector Servicing
- 4.9 Cleaning of Vent
- 4.10 Re-commissioning after Service

## 5 Troubleshooting Guide

## 6 Replacing Parts

- 6.1 Burner Controller Replacement
- 6.2 Air Pressure Switch Replacement
- 6.3 Gas Valve Replacement

## 7 User and Operating Instructions

- 7.1 To Start Heater
- 7.2 To Switch Off Heater
- 7.3 Servicing

# 1. Installation Requirements.

## 1.1 Health and Safety

- A. Heater is intended for heating non-residential indoor spaces and should only be installed where flammable gases or vapors are not present.
- B. Heaters can be suspended horizontally or at any angle along the axis of the emitter tubes but can only be rotated about the burner head 0 to 55°. See section 1.3 for clearance dimensions.

- C. The installation must conform with local building codes or, in the absence of local codes, with the *National Fuel Gas Code, ANSI Z223.1/NFPA 54* or the *Natural Gas and Propane Installation Code, CSA B149.1*.
- D. The unit shall be electrically grounded in accordance with National Electric Code ANSI/NFPA 70 and Canadian Electrical Code CSA C22.1.

E. The heater may be installed in aircraft hangars in accordance with the Standard for *Aircraft Hangars, ANSI/NFPA 409* and in automotive garages when installed in accordance with the Standard for *Parking Structures, ANSI/NFPA 88A*, or the Standard for *Repair Garages, ANSI/NFPA 88B*, or the *Canadian Natural Gas and Propane Installation Code, CSA B149.1*, and are so marked. Ensure that minimum clearances will be maintained to vehicles parked below the heater.

F. The standard heaters are approved for installations between 0 - 2000ft (0 - 610m) above sea level for the US and 0 - 4500ft (1370m) above sea level for Canada. Conversion kits are available on installations above these heights in the USA.


G. **Massachusetts Requirement:** If the heater is being installed in the Commonwealth of Massachusetts, this unit must be installed by a licensed plumber or licenced gas fitter.

## 1.2 Heater Suspension

Attachment to the heater support lugs should be made by D shackle. The hanging attachments to overhead steelwork etc. have to be designed and produced in accordance with sound engineering practices. They must be adequately fixed and designed to carry the whole weight of the heater. In the event of suitable roof steelwork being unavailable, additional steelwork should be fitted to enable vertical hangers to be used for suspending the heaters.

These methods are illustrated in Figure 1. If there are any doubts as to the strength or suitability of roof steelwork to which heaters are to be suspended, please refer to a Consultant, Architect or owner of the building.

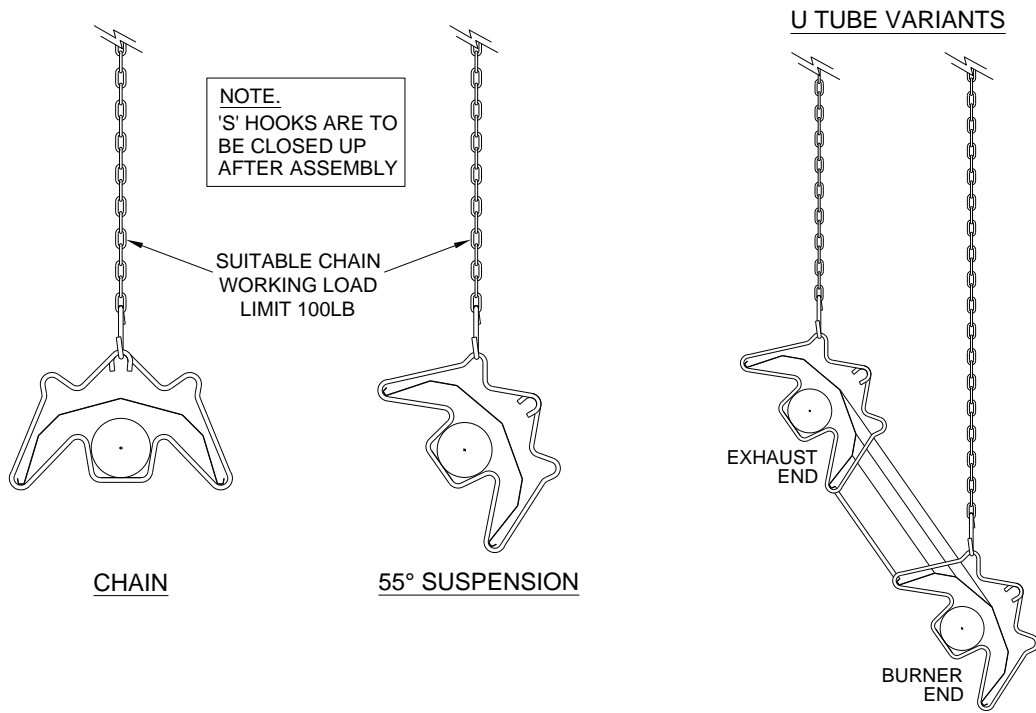
It is recommended that the heater is raised to its final position once the assembly of the emitter tube/bracket/reflector has been completed. Longer tube assemblies may be raised in more than one sub-assembly with final emitter tube connection made in the air.



### WARNING:

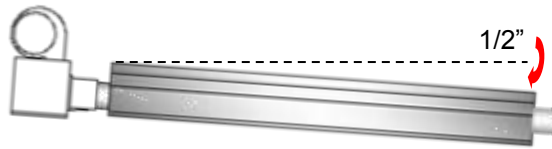
If not installed, operated and maintained in accordance with the manufacturer's instructions, this product could expose you to substances in fuel or from fuel combustion which are known to the state of California to cause cancer, birth defects or other reproductive harm.

Figure 1. Recommended Methods of Heater Suspension.

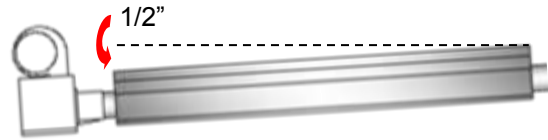




**ON VENTED HEATERS, THE HEATER SHOULD SLOPE DOWNWARDS AWAY FROM THE BURNER AND ON UNVENTED HEATERS SHOULD SLOPE DOWNWARDS TOWARDS BURNER BY APPROX. 1/2" OVER TOTAL HEATER LENGTH AS SHOWN BELOW (DIAGRAMS EXAGGERATED FOR CLARITY).**



**VENTED**



**UNVENTED**

### 1.3 Clearance to Combustibles.

Minimum clearance to combustibles are shown in Table 1 below.

**IMPORTANT:**


The stated clearance to combustibles represents a surface temperature of 90°F (50°C) above room temperature. Building material with a low heat tolerance (such as plastics, vinyl siding, canvas, tri-ply, etc.) may be subject to degradation at lower temperatures. It is the installer's responsibility to assure that adjacent materials are protected from degradation.

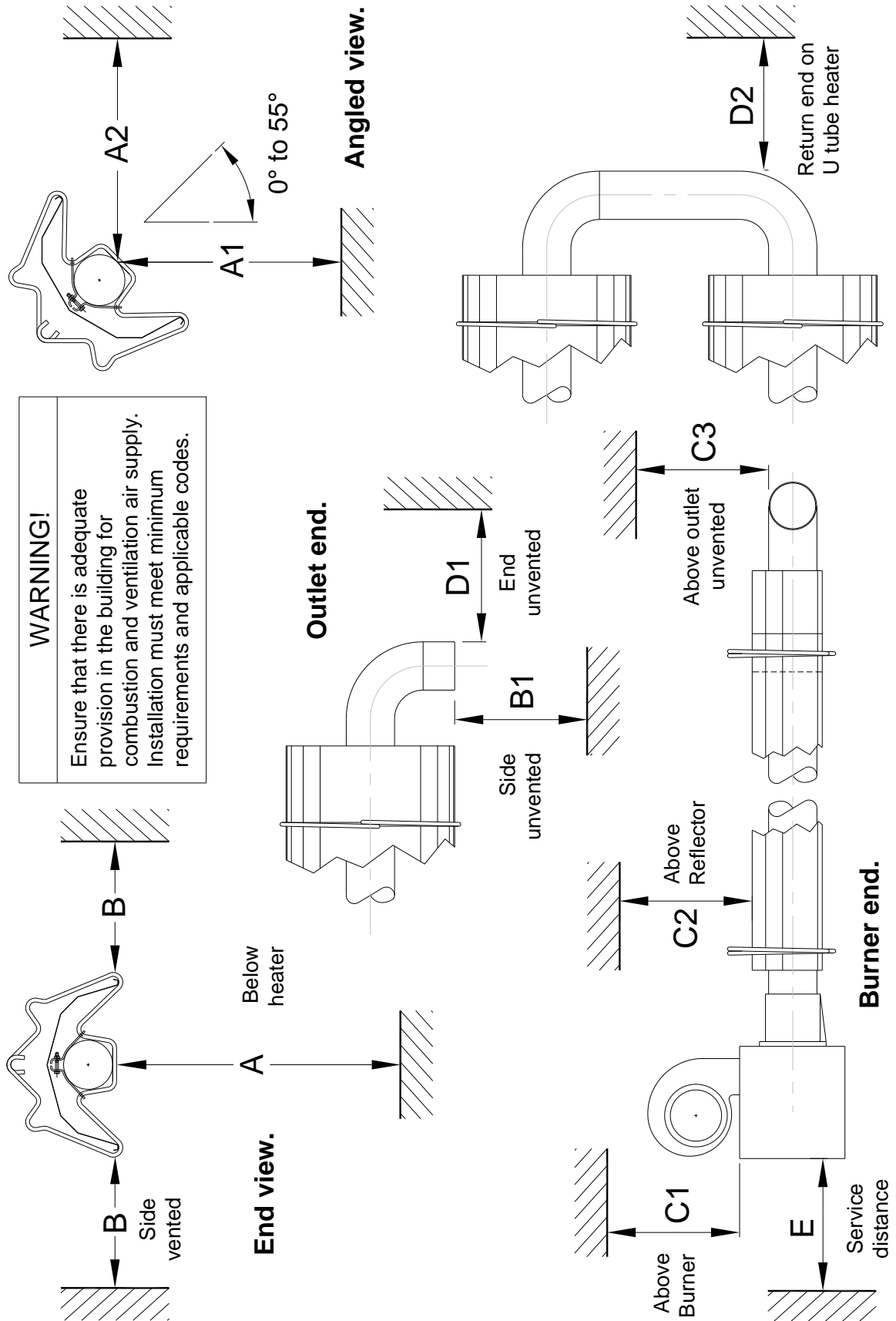
Table 1 Clearance to Combustibles, inches (cm)										
MODEL	A	A1 / A2	B	B1	C1	C2	C3	D1	D2	E
60	74 (188)	15° = 72 (183) 25° = 68 (173) 35° = 61 (155) 45° = 53 (135) 55° = 43 (110)	29 (74)	41 (105)	20 (51) / 10* (26)*	8 (21)	22 (56)	8 (21)	12 (31)	12 (31)
80	74 (188)		29 (74)	41 (105)	20 (51) / 10* (26)*	8 (21)	22 (56)	8 (21)	12 (31)	12 (31)
100	74 (188)		32 (82)	41 (105)	20 (51) / 10* (26)*	8 (21)	22 (56)	8 (21)	16 (41)	12 (31)
125	74 (188)		39 (99)	47 (120)	20 (51) / 10* (26)*	8 (21)	22 (56)	20 (51)	18 (46)	12 (31)
150	74 (188)		39 (99)	48 (122)	20 (51) / 10* (26)*	8 (21)	22 (56)	20 (51)	18 (46)	12 (31)
170	86 (219)		48 (122)	48 (122)	20 (51) / 10* (26)*	11 (28)	22 (56)	20 (51)	20 (51)	12 (31)
200	86 (219)	48 (122)	48 (122)	20 (51) / 10* (26)*	11 (28)	22 (56)	20 (51)	20 (51)	12 (31)	

\* distance with end caps fitted.

**WARNING:** Minimum clearance from the heater must be maintained from vehicles parked below heater. In all situations, clearances to combustibles must be maintained. Signs should be posted in storage areas to specify maximum stacking height to maintain required clearance to combustibles. Such signs must either be posted adjacent to the heater thermostats or in the absence of such thermostats in a conspicuous location. Refer to mounting clearance tables.

**Figure 2 Clearance to Combustibles.**

 The minimum clearances to combustibles materials are given in Table 1 These minimum distances **MUST** be adhered to at all times. Adequate clearance **MUST** be provided around air openings into the combustion chamber and there **MUST** be suitable clearance for accessibility and for combustion / ventilating air supplies.



## 1.4 Gas Connection and Supply

**⚠ WARNING:** Before installation, check that the local distribution conditions, nature of gas and pressure, and adjustment of the appliance are compatible.

The gas connection on the heater is ½" N.P.T internal thread.

Injector sizes and manifold pressure for the burners are shown in Table 5. The gas supply piping and connections must be installed so that the minimum pressure stated is achieved.

A gas shut off valve and union should be fitted in the gas supply line close to the heater and a ⅛" N.P.T plugged tapping, accessible for test gauge connection, provided immediately upstream of the appliance gas inlet.

It is essential to provide some flexibility in the final gas connection by use of an approved flexible gas connector (see Figure 4).

**i** Take care when making a gas connection to the heater not to apply excessive turning force to the internal controls.

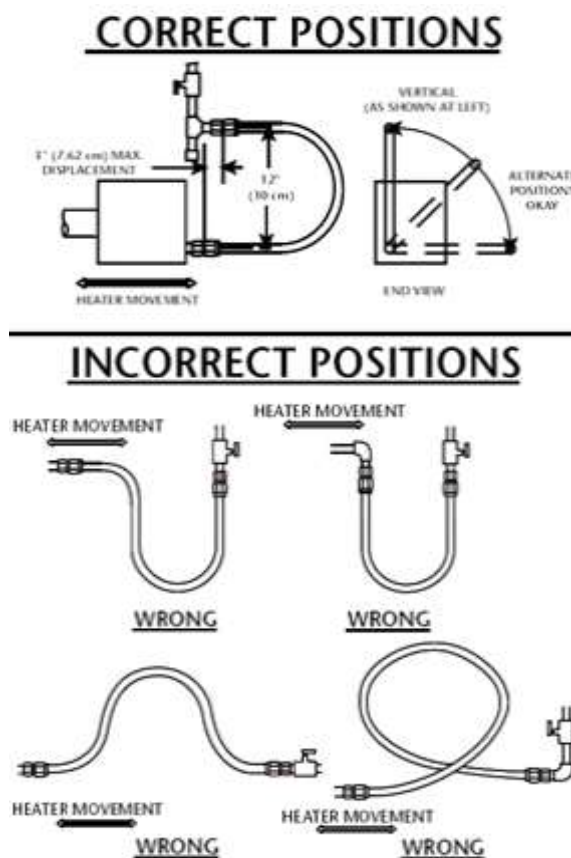
Care must be taken to observe the pipe bend diameter of 12" (30cm) and pipe displacement distance of 3" (7.62cm).

**i** The correct installation as shown will allow for approx. 4" of movement due to expansion.

Figure 3. Correct orientation of Ball Valve



Figure 4. Correct Installation of Flexible Gas Connection




**⚠ WARNING: FIRE OR EXPLOSION HAZARD** - It is essential to provide some flexibility in the final gas line connection by use of an approved flexible connector as shown in the drawings. Expansion of the radiant pipe occurs with each firing cycle causing the burner to move with respect to the gas line. This can result in a gas leak producing an unsafe condition.

\* Connector must be certified for use on a radiant tube type infrared heater and must comply with Standard for Connectors for Gas Appliances, ANSI Z21.24/CSA 6.10 or with the Standard for Elastomeric Composite Hose and Hose Couplings for Conducting Propane and Natural Gas, CAN/CGA 8.1.

For heaters up to 150,000Btu/h, 1/2" ID x 24" long  
 For heaters above 150,000Btu/h, 3/4" ID x 36" long  
 NOTE: For Canada all heaters MUST use a hose 36" long (see Table 2).

**Table 2**


HOSE SIZE	USA	CANADA
3/4"	CE4	CONTACT FACTORY

 **CONNECTOR MUST BE INSTALLED IN A "U" CONFIGURATION. FOR HEATERS UP TO 150,000 BTU/H, A 24" LONG CONNECTOR OF AT LEAST 1/2" ID MUST BE USED. FOR HEATERS ABOVE 150,000 BTU/H, A 36" LONG CONNECTOR OF AT LEAST 3/4" NOMINAL ID MUST BE USED.**

**Table 3 Gas Supply & Pressures**

Gas Type	Natural Gas	LP/Propane Gas
<b>Min Required Gas Pressure (in W.C) (60,000 TO 150,000 BTU)</b>	5.0	11.0
<b>Min Required Gas Pressure (in W.C) (170,000 TO 200,000 BTU)</b>	7.0	11.0
<b>Max Supply Pressure (in W.C)</b>	14.0	14.0
<b>Gas Supply</b>	Connection 1/2" N.P.T thread	

**1.5 Electrical Connections**

 **WARNING: Before making electrical connections, switch OFF the main electrical disconnect. There may be more than one disconnect switch. Lock out and tag switch with a suitable warning label. Electrical shock can cause personal injury or death.**

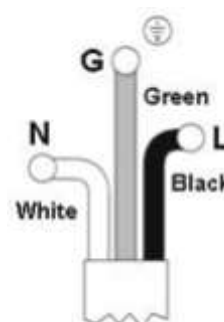
The electrical supply to the heater is by three wires: live, neutral and ground connections. Install in accordance with all state & local codes.

Where alternative manufacturers controls are used, please refer to their instructions for installation details.

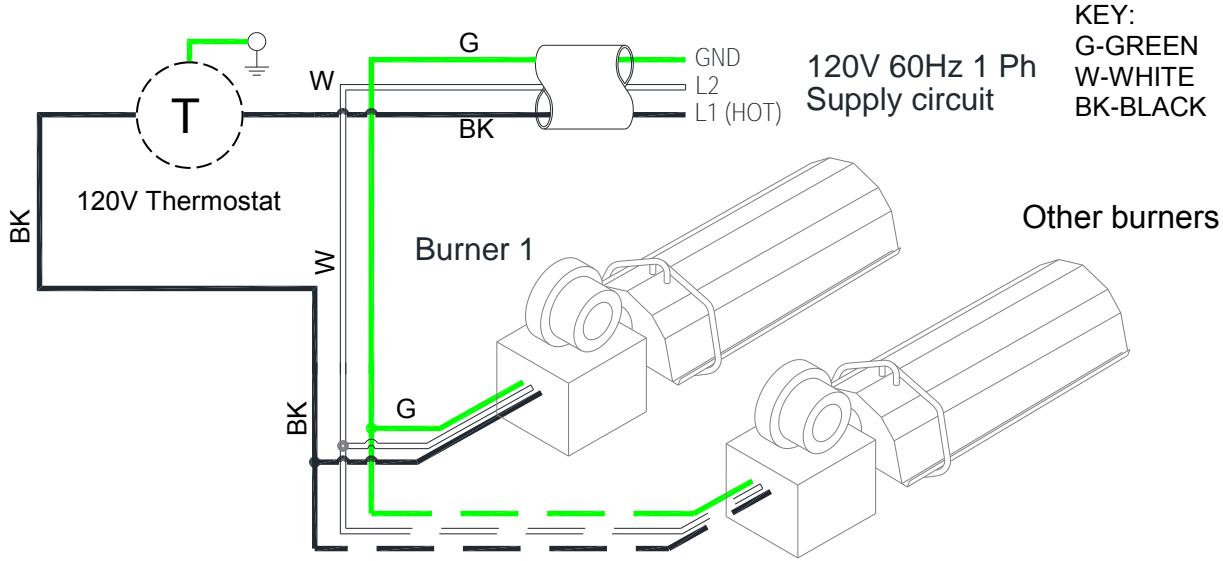
This appliance must be electrically grounded

Supply: 120V 60Hz single phase.  
 Standard heater: 0.16HP.  
 Current rating (inductive):  
     1.8 amp max (models 60 - 150)  
     1.0 amp max (models 170 & 200)  
 Fuse: external 3 amp.

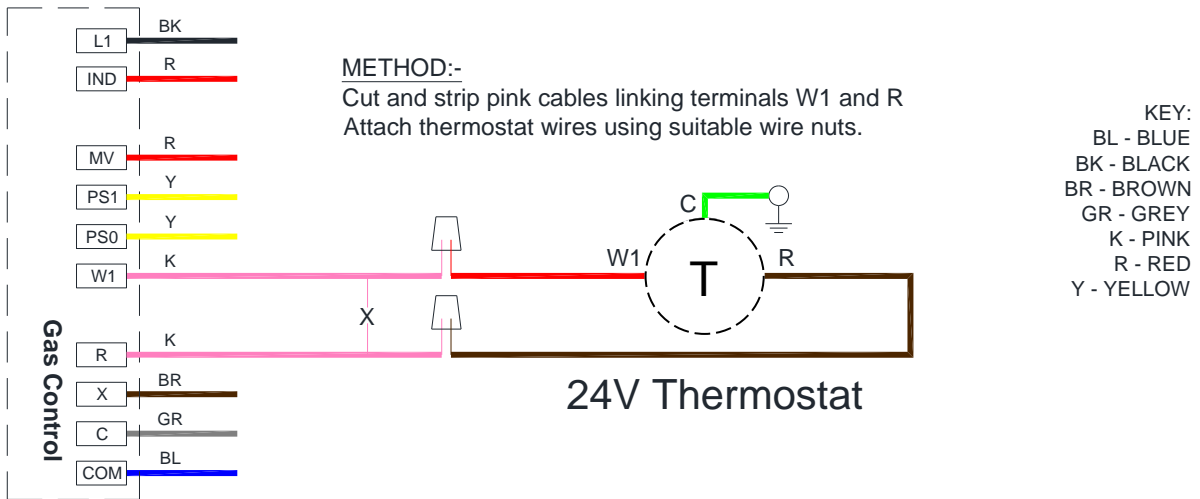
Important: All electrical work should be done by a qualified electrician in strict accordance with the National Electrical Code ANSI/NFPA 70 or Canadian Codes CSA C22.1.



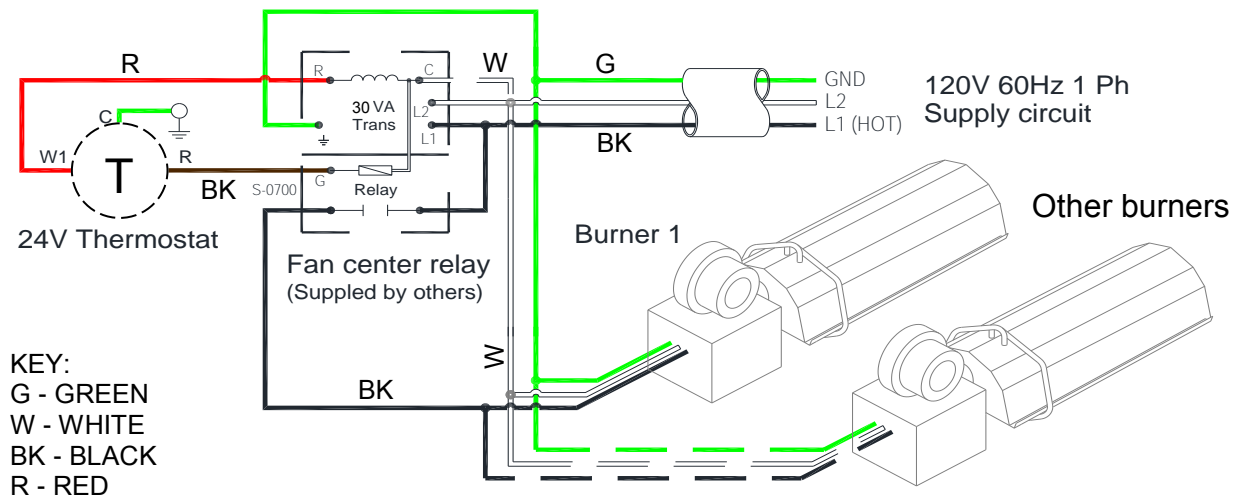
**Figure 5a. Single and Multiple Heater Installations 120V Control**



**Figure 5b. Single Heater Installations 24V Control**

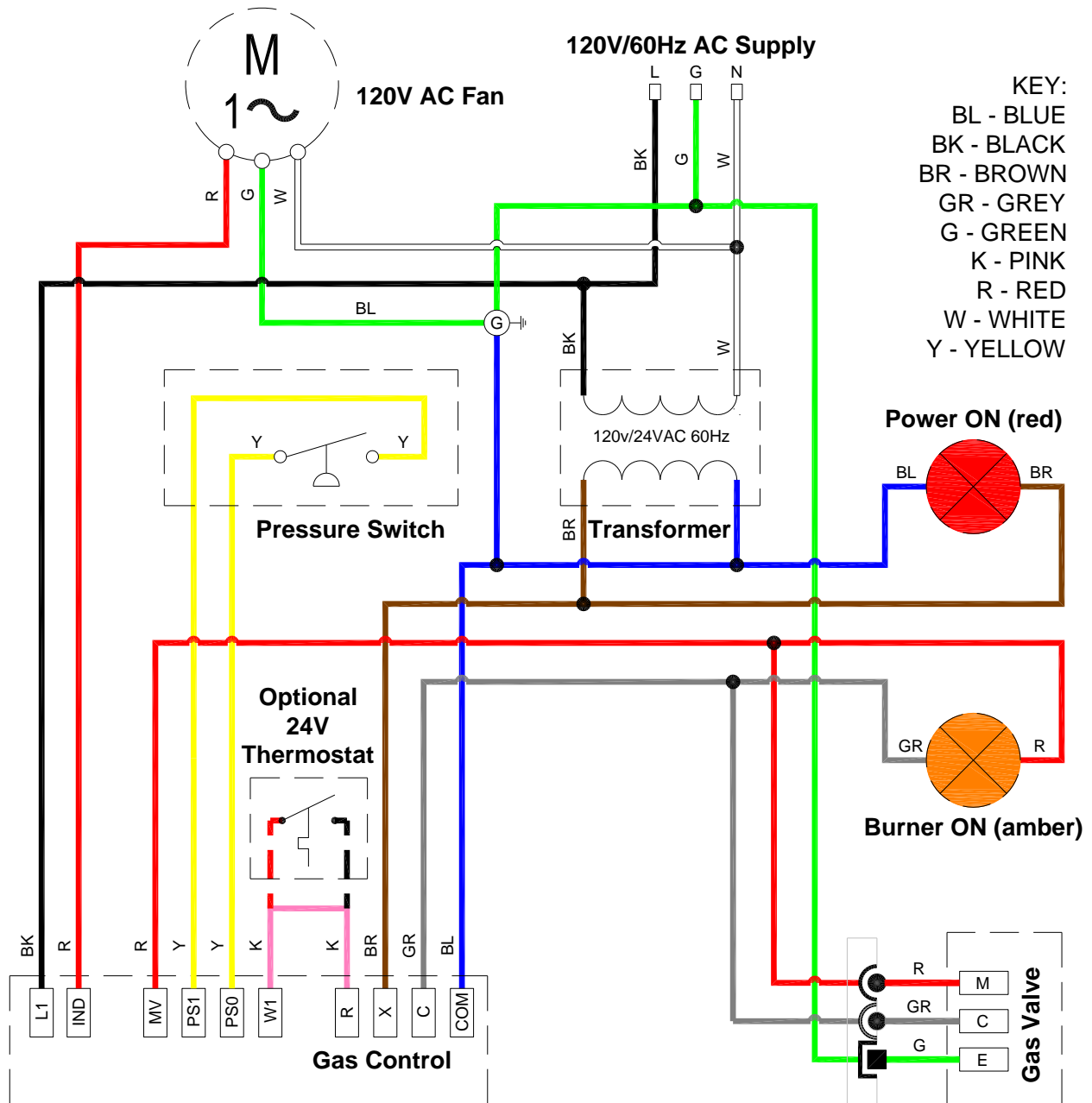


**Figure 5c. Multiple Heater Installations 24V Control**





**Figure 6. Internal Burner Wiring Diagram.**



**NOTES:-**

Power On light is permanently illuminated when 120V / 60 Hz AC external supply is connected to burner.

Additional wiring is required to install an optional extra thermostat and / or time clock.

If no thermostat is required then a jumper is fitted between terminals R and W1. In this configuration the burner will continuously fire until the 120V power supply is disconnected.

Wire specification:- 18 AWG (1.0mm<sup>2</sup>), Tri-rated, 105°C

**!** If any of the original wire as supplied with the appliance must be replaced, it must be replaced with wiring material having a temperature rating of at least 220°F/105°C

## 1.6 Vent Requirements and Details

### 1.6.1 Unvented Units

Heaters may be installed unvented providing the governing building codes are met and consideration is properly given to possibilities of condensation on cold surfaces.

Installation shall meet the following requirements when unvented:

- Natural or mechanical means shall be provided to supply and exhaust at least 4 CFM per 1000 BTU per hour input of installed heaters.
- Combustion gases shall not impinge on combustible materials.

### 1.6.2 Vented Units

Heaters can be installed with either vertical or horizontal vents.

VPS heaters are certified as Category III for vertical and horizontal vent installations. Use appropriate venting materials. Refer to Table 4 for approved Category III vent manufacturers.

#### 1.6.2.1 Vertical Venting

The heater can be installed with a vertical vent.

All vent piping should be adequately supported from the building structure and terminated with an approved terminal. **The maximum recommended vent length is 25ft (7.6m) with a maximum of two elbows.** All connections should be properly sealed (see Figure 7a).

#### 1.6.2.2 Horizontal Venting

Individual units can be vented horizontally through side walls. Recommended terminals are Part Numbers 111848 for 4" and 111850 for 6".

Distances from adjacent public walkways, adjacent buildings, openable windows and building openings, consistent with the *National Fuel Gas Code, ANSI Z223.1/NFPA 54* or the *Natural Gas and Propane Installation Code, CSA B149.1*.

**The maximum recommended vent length is 25ft (7.6m) with a maximum of two 90° elbows.** However runs up to 12ft (3.6m) can use 4" (101mm) vent pipe. Runs over 12ft

(3.6m) should always use 6" (152mm) vent pipe.

An approved clearance thimble is required when the flue pipe passes through combustible materials. Follow the requirements of the thimble manufacturer.

Standard vent terminals must extend at least 6" (152mm) from the wall and at least 24" (609mm) from any combustible overhang. This protects the building material from degradation by the vent gases (see Figure 7b).

Vent joints should be sealed and secured according to the vent manufacturers instructions. Should condensation occur the vent should be shortened or insulated.

The terminal should be at least 3ft (0.91m) from any air intake to the building.

The vent terminal must be installed at a suitable height above the ground to prevent blockage by snow.

## 1.7 Fresh Air Intake

Whenever the heater is installed in locations where airborne dust or other pollutants are present, a fresh air supply should be ducted to the burner.

If the heater is equipped with ducted combustion air, the vent terminal must be at least 3ft (0.91m) away from the air inlet and located higher than the inlet.

A fresh air duct of 4" (101mm) diameter should be installed from the fresh air to the air intake connection on the fan housing. A flexible jointing piece should be installed at the fan connection with hose clamps to facilitate expansion and contraction.

The maximum recommended length air duct is 25ft (7.6m) and the maximum number of elbows is two. The minimum length is 18" (456mm).

The location of the fresh air duct inlet must be where it will receive dust free clean air. An inlet cap with bird screen must be fitted at the inlet of the duct. If the duct inlet is located above the roof the underside of the inlet terminal must be at least 2ft (0.61m) above roof level (or above projected snow load) and at least 10" (254mm) above any projection on the roof within 7ft (2.1m) of the inlet. Intake pipe, fittings and sealant are not furnished by the manufacturer (see Figures 7b & 7c).

**Table 4 Approved Category III Vent Manufacturers**

<b>Manufacturer</b>	<b>Model</b>	<b>Size(s) (Inches)</b>		
Captive-Aire Systems Inc	2V-Type BH	—		
Cheminée Lining.E Inc	IPP, HEP, HEPL, HEPLA, HEPL1, and HEPL2	6–48 DIA		
Cleaver-Brooks	CBH, CBHL, CBHL2, CBHLA, and CBHL1	6–48 DIA		
DuraVent Inc	FasNSeal fixed blade damper assembly	4–18 ID		
	FasNseal special gas vent assembly	—		
	FasNSeal W2 special gas vent system	—		
	FasNSmooth chimney liner system (for use in masonry chimneys only)	—		
	FasNSeal CVS special gas vent system and direct vented pellet system	—		
	S-Vent and PVP	4 DIA	5 DIA	
Energex Inc	EPS and EPS-1	6–48 DIA		
Industrial Chimney Co	VIC	4–24 DIA		
Industrial Combustion, LLC	ICH, ICHL, ICHLA, ICHL1, and ICHL2	6–48 DIA		
Jeremias Inc	DWKL and SWKL	4–36 DIA		
	DWGV (double wall, air-insulated, 1-inch space between inner and outer pipe DIA)	—		
	DWGV1 (double wall, fiber-insulated, 1-inch space between inner and outer pipe DIA)	—		
	DWGV2 (double wall, fiber-insulated, 2-inch space between inner and outer pipe DIA)	—		
	SWG (single wall)	4–12 DIA		
	DWFL and SWFL	4–36 DIA		
Living Engineering Co, Ltd	KP and N-Vent	4 DIA	5 DIA	
Metal-Fab Inc	CGSW, FCSSW, CG, FCS, FCG-1, and FCS-1	6–24 ID		
	FCGSW, FCG, and FCG-1	6–36 ID		
	CGSW, CG, and FCG	4 DIA	5 DIA	
	3CGSWHVK and 4CGSWHVK	4 DIA	5 DIA	
	FCS-2 CORR/GUARD and FCS-3 CORR/	6–36 ID		
Noritz America Corp	N-Vent	4 DIA	5 DIA	
Selkirk Corp	Saf-T-Vent EZ Seal, Saf-T-Vent GC, Saf-T-Vent SC, and Saf-T-Vent CI	4 DIA	5 DIA	6 DIA
	Saf-T-Vent CI Plus	4 DIA	5 DIA	6 DIA   8 DIA
	SGV	4 DIA	5 DIA	
	SC, DGV, and EZ Seal Quick Kit	4 DIA		
	Sel-Vent and Sel-Vent II	4 DIA		
	IPS316, PS316, and G316	5 DIA	6 DIA	
SFL	DEVON EPS and EPS-1	4–6 DIA		
The Schebler Co	SSD, ESW, eVent, eVent PLUS, eVent PLUS 2, and eVent SD	4–6 DIA		
Van-Packer Co Inc	MW, CS, and CSplus	4–6 ID		
Z-Flex U.S. Inc	SVE, SVEII, and SVEIII	4 DIA		
	SVEIV Single Wall, SVEIV Double Wall, NovaVent Single Wall, and NovaVent Double Wall	4 DIA	5 DIA	6 DIA

Figure 7.a Vertical Venting.

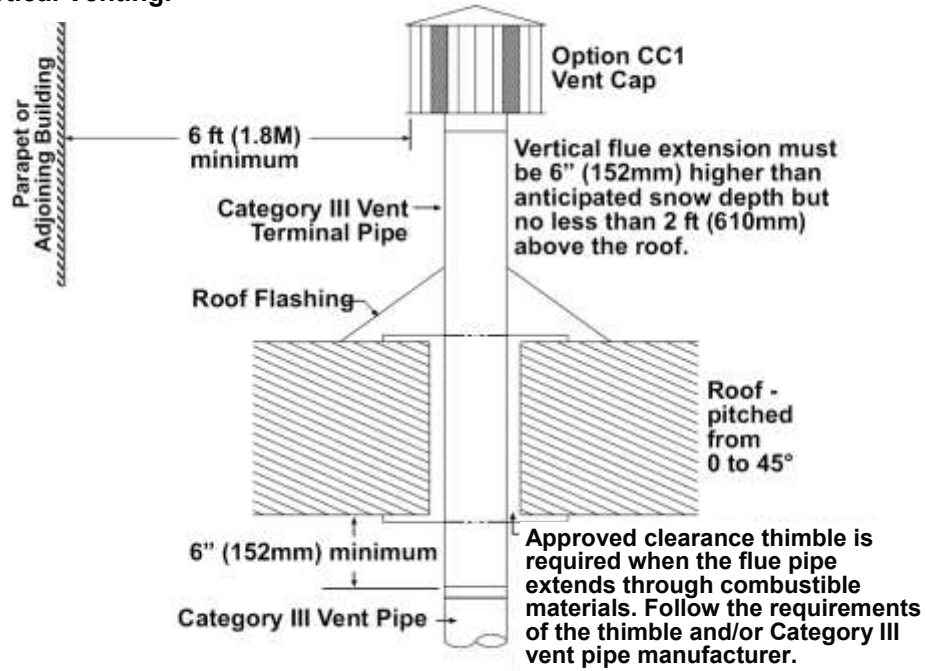


Figure 7.b Horizontal Venting (plan view shown).

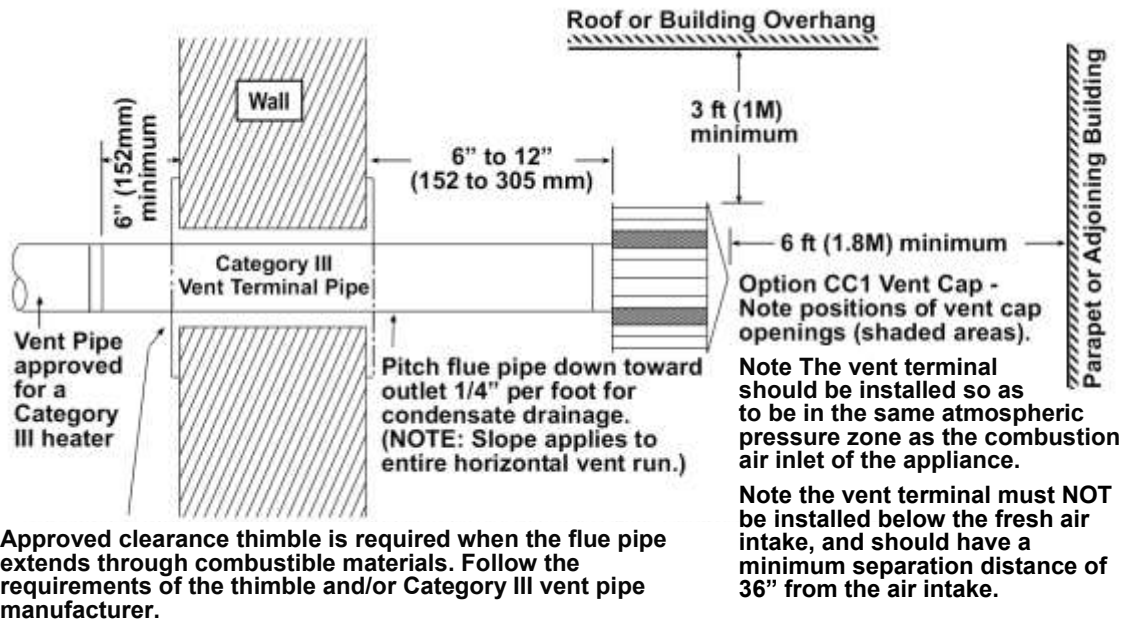
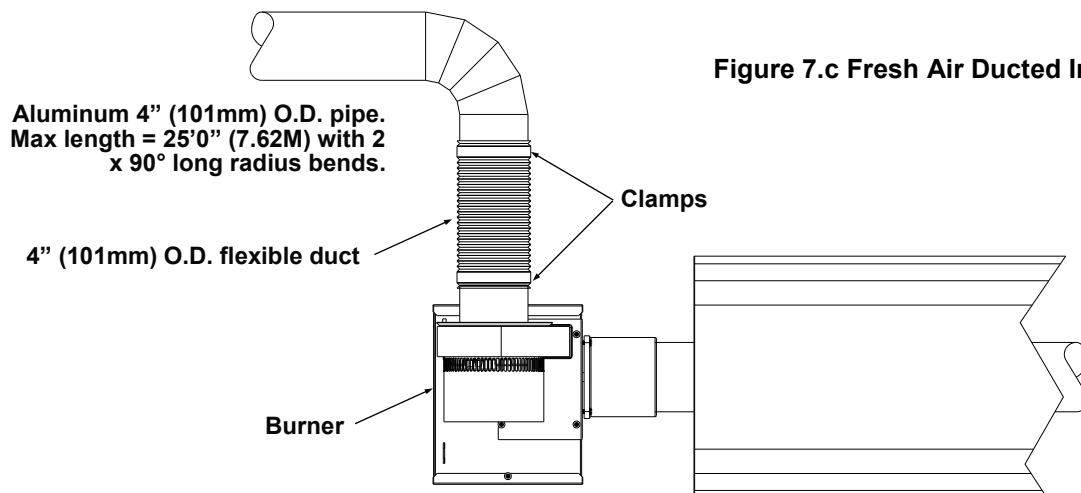


Figure 7.c Fresh Air Ducted Intake.



**1.8 Technical Details - Table 5**

<b>No of Injectors</b>	1
<b>Gas Connection</b>	½" N.P.T
<b>Electrical Supply</b>	120 volt 1 phase 60Hz
<b>Vent size (in)</b>	4" or 6" (101mm or 152mm)
<b>Unitary Fan Motor Details</b>	120 volt, 1 phase 60Hz
<b>Current Rating</b>	1.8A MAX (models 60 - 150); 1.0A MAX (models 170 & 200)
<b>Ignition</b>	Electronic Program Start up with Spark Ignition

MODEL	Natural Gas	LP Gas	Min. Heater Length	Max. Heater Length	Min. Heater Length	Max. Heater Length
	BTU/Hr	BTU/Hr	S ft	S ft	U ft	U ft
<b>60</b>	60,000	60,000	20	40	20	40
<b>80</b>	80,000	80,000	30	40	20	40
<b>100</b>	100,000	100,000	30	50	40	40
<b>125</b>	123,500	125,000	30	60	40	60
<b>150</b>	150,000	150,000	40	70	40	60
<b>170</b>	169,000	169,000	50	80	60	80
<b>200</b>	200,000	<b>N/A</b>	50	80	60	80

Appliances can be installed up to 10,000ft above sea level in the USA. Altitude conversion kits are available on request.

USA	0- 2000 ft (0-610m) above sea level						
Size	60	80	100	125	150	170	200
<b>NG "WC</b>	3.9	3.5	4.5	4.3	4.0	3.3	3.3
<b>LP "WC</b>	5.5	5.2	8.0	7.6	7.0	6.1	N/A

CANADA	0- 2000 ft (0-610m) above sea level						
Size	60	80	100	125	150	170	200
<b>NG "WC</b>	3.9	3.5	4.5	4.3	4.0	3.3	3.3
<b>LP "WC</b>	5.5	5.2	8.0	7.6	7.0	6.1	N/A

USA & CANADA	Natural Gas 0- 2000 ft (0-610m) above sea level						
Size	60	80	100	125	150	170	200
<b>Burner Orifice Plate Part No.</b>	269941	269942	269943	269944	1005513	269946	269946
<b>Flame Plate Part No.</b>	N/A						
<b>Fan Part No.</b>	270476	270476	270476	270476	270476	270475	
<b>Fan Orifice Part No.</b>	269922	269925	269925	269930	269931	269935	269938
<b>Injector Part No.</b>	270400	270402	270403	270405	270407	270409	270410
<b>Injector Carrier Part No.</b>	270375					270376	
<b>Pressure Switch Part No.</b>	270389						270390

USA & CANADA	LP Gas 0- 2000 ft (0-610m) above sea level						
Size	60	80	100	125	150	170	200
<b>Burner Orifice Plate Part No.</b>	269948	269949	269950	269951	269952	269953	N/A
<b>Flame Plate Part No.</b>	269957	269958		269959		269960	
<b>Fan Part No.</b>	270476					270475	
<b>Fan Orifice Part No.</b>	269924	269925	269929	269931	269933	269937	
<b>Injector Part No.</b>	270398	270399		270400	270401	270403	
<b>Injector Carrier Part No.</b>	270375						
<b>Pressure Switch Part No.</b>	270389						


**Technical Details continued**

MODEL	U Tube				Straight Tube						
	U20	U40	U60	U80	S20	S30	S40	S50	S60	S70	S80
60	•	•			•	•	•				
80	•	•				•	•				
100		•				•	•	•			
125		•	•			•	•	•	•		
150		•	•				•	•	•	•	
170			•	•				•	•	•	•
200*			•	•				•	•	•	•


\* Nat Gas ONLY


MODEL	Emitter Tube Type Material		Min. Distance to Bend ft (m)
	Calcoat™	Mild Steel	
60	TUBE 1	REMAINDER	10 (3.0)
80	TUBE 1	REMAINDER	10 (3.0)
100	TUBE 1	REMAINDER	15 (4.6)
125	TUBE 1	REMAINDER	15 (4.6)
150	TUBE 1	REMAINDER	20 (6.1)
170	TUBE 1 & 2	REMAINDER	25 (7.6)
200	TUBE 1 & 2	REMAINDER	25 (7.6)

## 2. Assembly Instructions.

 **PLEASE READ** this section prior to assembly to familiarize yourself with the components and tools you require at the various stages of assembly. Carefully open the packaging and check the contents against the parts and check list.

The manufacturer reserves the right to alter specifications without prior notice.

 Please ensure that all packaging is disposed of in a safe environmentally friendly way.

 For your own safety we recommend the use of safety boots and leather faced gloves when handling sharp or heavy items. The use of protective eye wear is also recommended.

### 2.1 Tools Required

The following tools and equipment are advisable to complete the tasks laid out in this manual.



Saw Horses



Leather Faced Gloves



Phillips Screwdriver



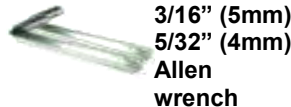
Wrench Set



Cordless Drill



5/16" Drive




3/16" (5mm)  
5/32" (4mm)  
Allen wrench



Tape Measure

 Suitable alternative tools may be used.

### 2.2 Assembly Notes

 Please read these assembly notes in conjunction with the correct assembly drawings (figs 9 to 19).

#### 2.2.2 Turbulator Strips and Burner Inserts

Ensure that the correct turbulator or burner insert is fitted, as this could void your warranty if they are incorrectly fitted or omitted when necessary.

##### 2.2.1 Emitter Tubes

Each heating unit has two types of emitter tube. For details of the emitter tube types and position please refer to the table (page 14 of this instruction manual).

Identify and position emitter tubes on saw horses. For aesthetics it is advisable to position **all tube seams facing down**. Position coupling fastener so that these cannot be seen from beneath the heater.

Mark out the position of the bracket centers from the dimensions shown on the assembly drawings.

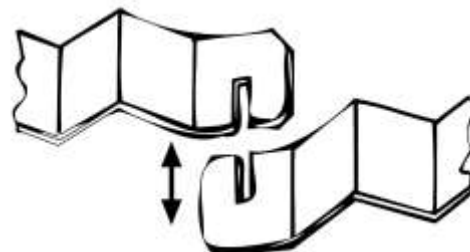


##### 2.2.2.1 Turbulator Strips

Turbulator strips should be inserted (when required) into the correct emitter tube exactly as indicated in the assembly drawings.

Locate turbulator strip sections. Install the first turbulator strip into the open end of the last emitter tube (only after it has been suspended and connected to the previous emitter tube.)

Interlock the next section of turbulator strip as shown in the diagram below.

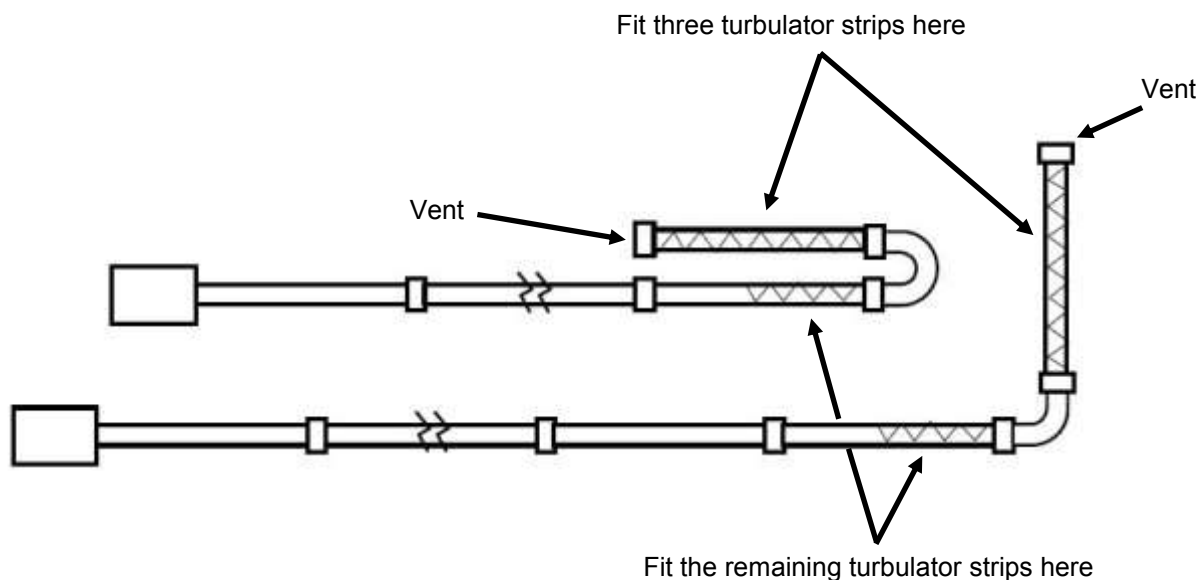




Slide the connected sections into the emitter tube(s). Add further strips to form the correct length required.

Where a heater configuration requires more than three turbulator strips and has the exhaust heat exchanger tube adjacent to an "L" or "U" heat exchanger tube, refer to the diagram below for positions.

*For specific configurations see detailed assembly diagrams on pages 21 to 31.*

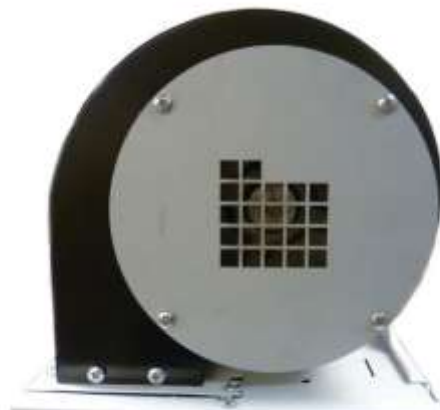


### **Model 200 S50 fan orifice plate**

This model has a different fan orifice plate (Part No.269939) to all other models in the range. It is supplied with every burner as a loose item and should be discarded if not needed. This must be fitted to the 200 S50 model only.

Remove the four fixing screws securing the existing orifice plate, then fit the replacement orifice plate with the correct air inlet hole orientation as shown in the picture opposite.

*Note: There should be 22 10mm x 10mm square holes in the replacement plate.*





### 2.2.2.2 Burner Inserts

The burner insert (when required) is inserted into the first emitter tube from where it is joined to the second emitter tube.

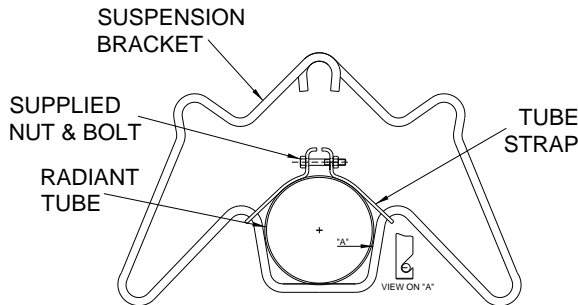


### 2.2.3 Brackets

There can be various styles of brackets supplied with these heaters:

#### 2.2.3.1 Suspension Brackets

2.2.3.1.1 Fixed suspension bracket assembly part #270126 & tube straps part #270572. **ONLY** used as the first suspension bracket positioned **CLOSEST TO THE BURNER**.



PARTS #270126 plus #270572

Slip the suspension first bracket assembly - part #270126 onto the first section of emitter tube in the position as indicated on the assembly drawing.

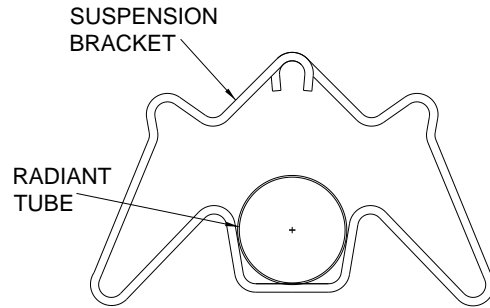
Locate the tube strap assembly part #270572 and loosen the nut and bolt.

Position the strap over the emitter tube and hook the two straps onto the suspension bracket.

Finally tighten the nut and bolt to secure the bracket onto the emitter tube.

2.2.3.1.2 Suspension brackets #270126 with no tube straps. For **ALL** other suspension brackets

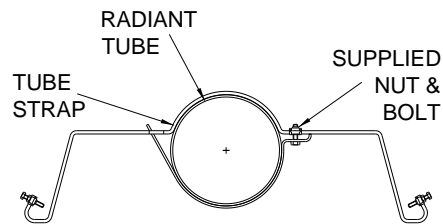
Once the emitter tubes have been assembled using the couplers (see section 2.2.4), position all other suspension brackets part #270126 onto the emitter tube(s) in their relevant positions as shown on the assembly drawing.



PART #270126

#### 2.2.3.2 Reflector Support Brackets

Reflectors are positioned above the emitter tube with a reflector support bracket part #270569.



REFLECTOR BRACKET #270569

Locate a suspension support bracket and remove the bolt fixing the strap to the bracket.

Position the bracket over the emitter tube and loosely replace the bolt.

Roughly position the support brackets in place along the emitter tube assembly as indicated on the assembly drawing. The positioning may need to be adjusted when the reflector is added.

### 2.2.4 Couplers

The couplers are used for joining emitter tubes and U or L bends.



Slide the coupling onto the end of the existing emitter tube. Slide the end of the next emitter tube into the other side of the coupling.

With both emitter tube ends pushed fully into the coupling and the bolts towards the bottom, using a 9/16" wrench, tighten the coupling bolts moving between each bolt in sequence to ensure equal pressure is applied to each bolt.

Complete assembly by drilling and screwing self tapping retention zip screws.



! At this point raise the tube assembly into position and suspend from previously fixed chains (Working Load 100lb). Longer tube assemblies may be raised in more than one sub-assembly with the final emitter tube connection made in the air.

### 2.2.5 Reflectors

! All reflectors must be positioned/ attached to the brackets exactly as detailed in the assembly drawings.

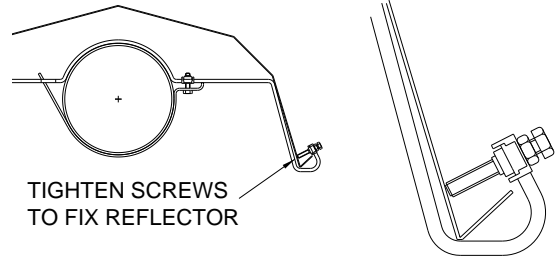
After removing the coloured protective plastic coating (where fitted), slip the reflectors through the suspension brackets until they overlap each other.

The first two reflectors are assembled and overlapped by a pre determined distance, as shown on the assembly drawing, and are fixed onto the emitter tube using the reflector support bracket part #270569.

! Each reflector must **OVERLAP** the previous one as indicated by their individual assembly sheets.

Reposition the reflector support bracket if necessary then tighten the clamp bolt.

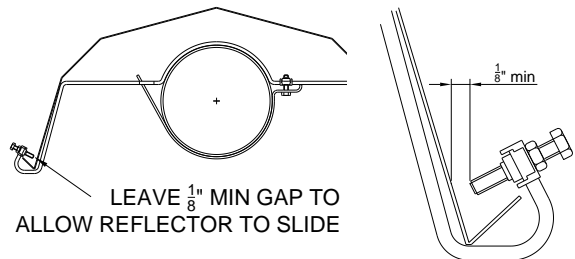
These two reflectors are fixed in place by tightening the fixing screws/locknuts as below. These are known as 'non-slip' overlaps.



The next reflector is assembled and overlapped by the pre determined distance. The reflector is fitted onto the emitter tube using another reflector support bracket part #270569.

Reposition the reflector support bracket if necessary, then tighten the clamp bolt.

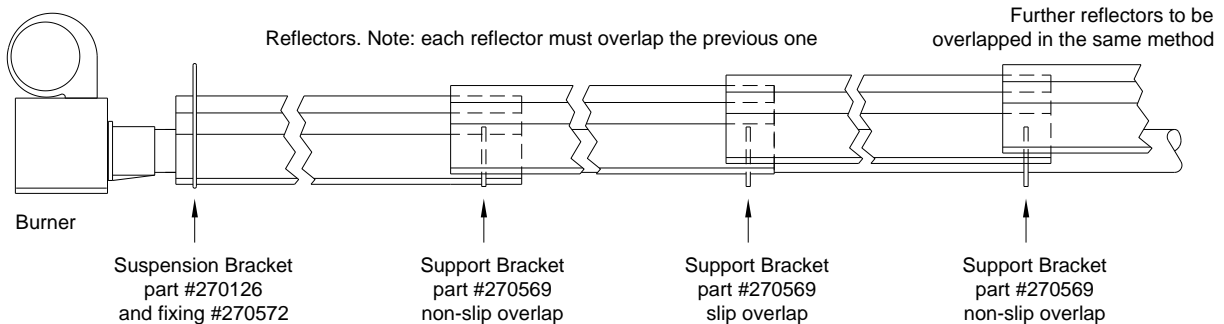
These overlapped reflectors are allowed to 'float' within the support bracket by leaving a minimum of 1/8" gap of the fixing screws before tightening the locknuts. These are known as 'slip' overlaps.



Further reflectors are assembled and overlapped onto the emitter tube by alternating 'non-slip' and 'slip' until complete length is covered.

Continue this method to the final reflector/support bracket.

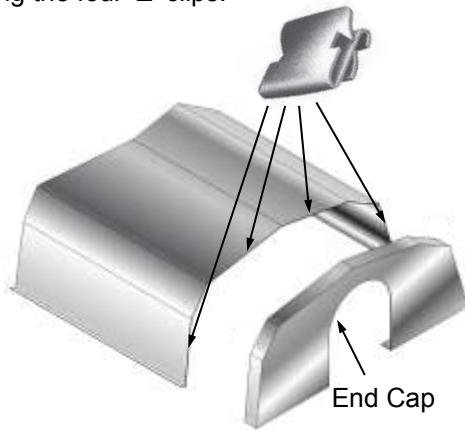
See sketch below for typical 'slip' and 'non-slip'.



Subsequent support brackets to be alternating 'slip' and 'non-slip'

### 2.2.6 End Caps (optional)

Position an end cap beneath the reflector profile (where required) with the end cap flanges facing inwards. Fasten to reflector using the four 'Z' clips.



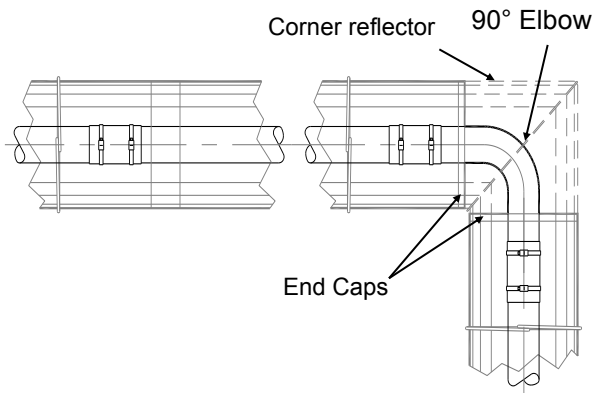
*Note: For high wind applications use additional drill screws to secure end cap to the reflector.*

### 2.2.7 Bend(s) (where fitted)

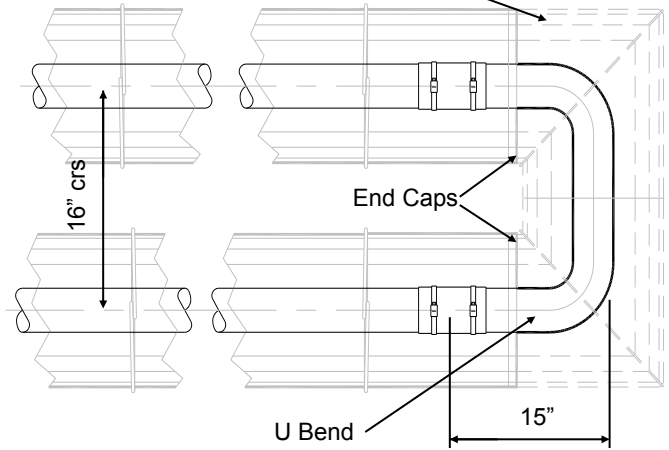
The heater can be installed with 1 or 2 90° bends or a 180° U bend.

Slide the bend into the open end of the coupler ensuring that the screw stop has butted up to the emitter tube ends. Refer to 2.2.4 for fastening.

Typical usage of optional bend kit: -



### Corner reflector kit



### 2.2.8 Burner/Fan Assembly

Slide the burner assembly onto the open emitter tube end, ensuring it is fully engaged. Secure with set screws.

For the purpose of unvented applications, a 4" 90° elbow should be used on the terminating end of the emitter tube sections and completed using a vent cap.



Connect Gas and Electrical supplies as described in sections 1.4 and 1.5.


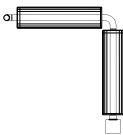


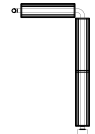


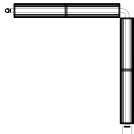
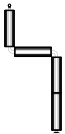



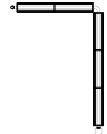
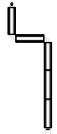
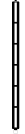

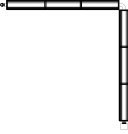
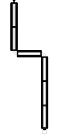
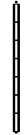

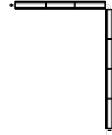
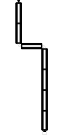


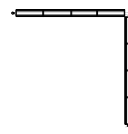
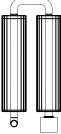

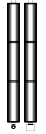

### 2.2.9 Detailed Assembly Drawings

The following pages show the technical dimensional details for the range of heaters available.

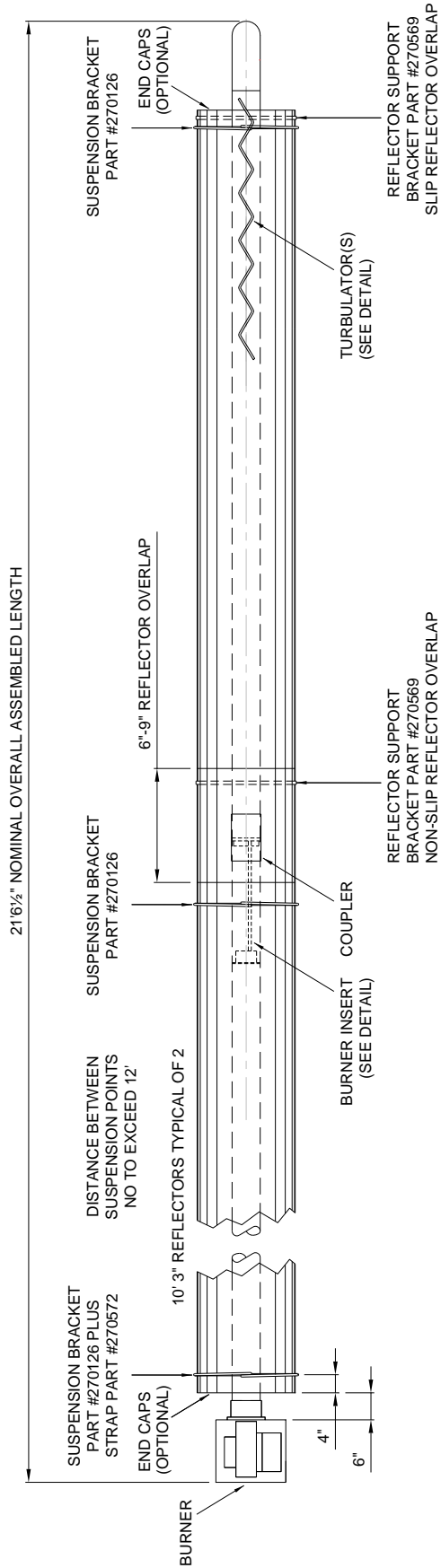
Please note the heater type, length and reference number from the delivery/advice note before identifying the correct model drawing.

**Figure 8. Possible Heater Orientations**

Bends must be fitted at a distance of at least 50% of the total heat exchanger e.g. for a 60ft long heater, the closest to the burner a bend can be is 30ft.

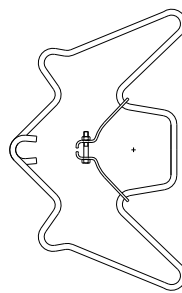
<b>S20</b>					
<b>S30</b>					
<b>S40</b>					
<b>S50</b>					
<b>S60</b>					
<b>S70</b>					
<b>S80</b>					
<b>U20</b>					
<b>U40</b>					
<b>U60</b>					
<b>U80</b>					

**Figure 9. Heater Assembly: Model Linear 60-S20**

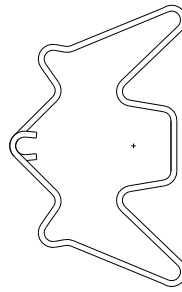


**ASSEMBLY OVERVIEW**

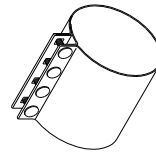
**DETAILS**



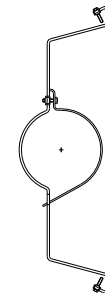
FIRST SUSPENSION POINT BRACKET  
PART #270126 plus STRAP #270572  
QTY 1 REQUIRED OF EACH



TUBE & REFLECTOR SUSPENSION  
BRACKET PART #270126  
QTY 2 REQUIRED



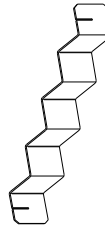
STANDARD 4" COUPLER  
PART #205546  
QTY 1 REQUIRED



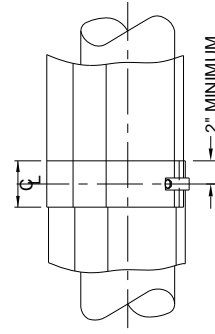
REFLECTOR SUPPORT BRACKET  
PART #270569  
QTY 2 REQUIRED



BURNER INSERT DETAIL  
PART #270489 (5FT)  
QTY 1 REQUIRED NAT GAS ONLY

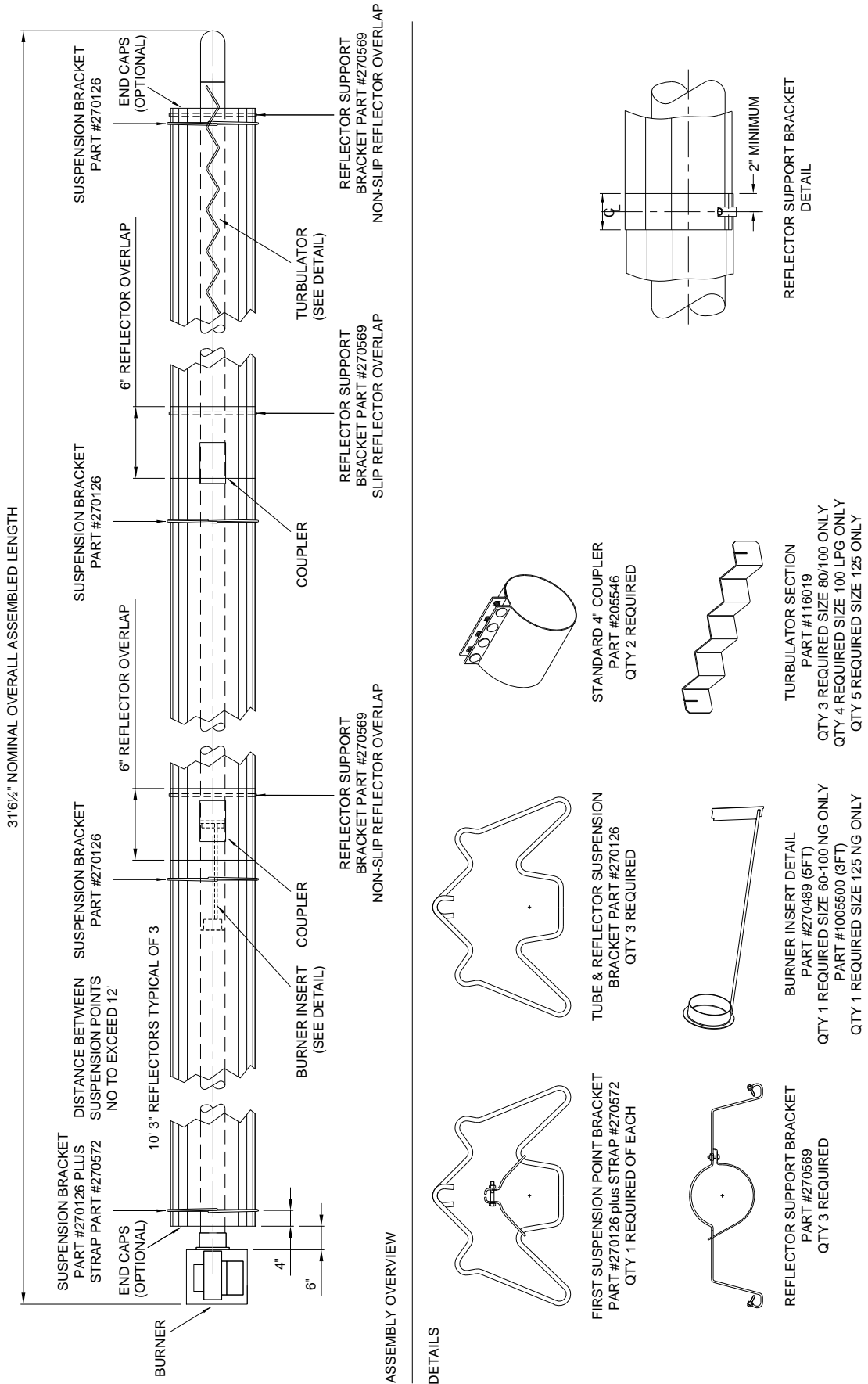


TURBULATOR SECTION  
PART #116019  
QTY 3 REQUIRED



REFLECTOR SUPPORT BRACKET  
DETAIL

**Figure 10. Heater Assembly: Model Linear 60-S30, 80-S30, 100-S30 and 125-S30**



**Figure 11. Heater Assembly: Model Linear 60-S40, 80-S40, 100-S40, 125-S40 and 150-S40**

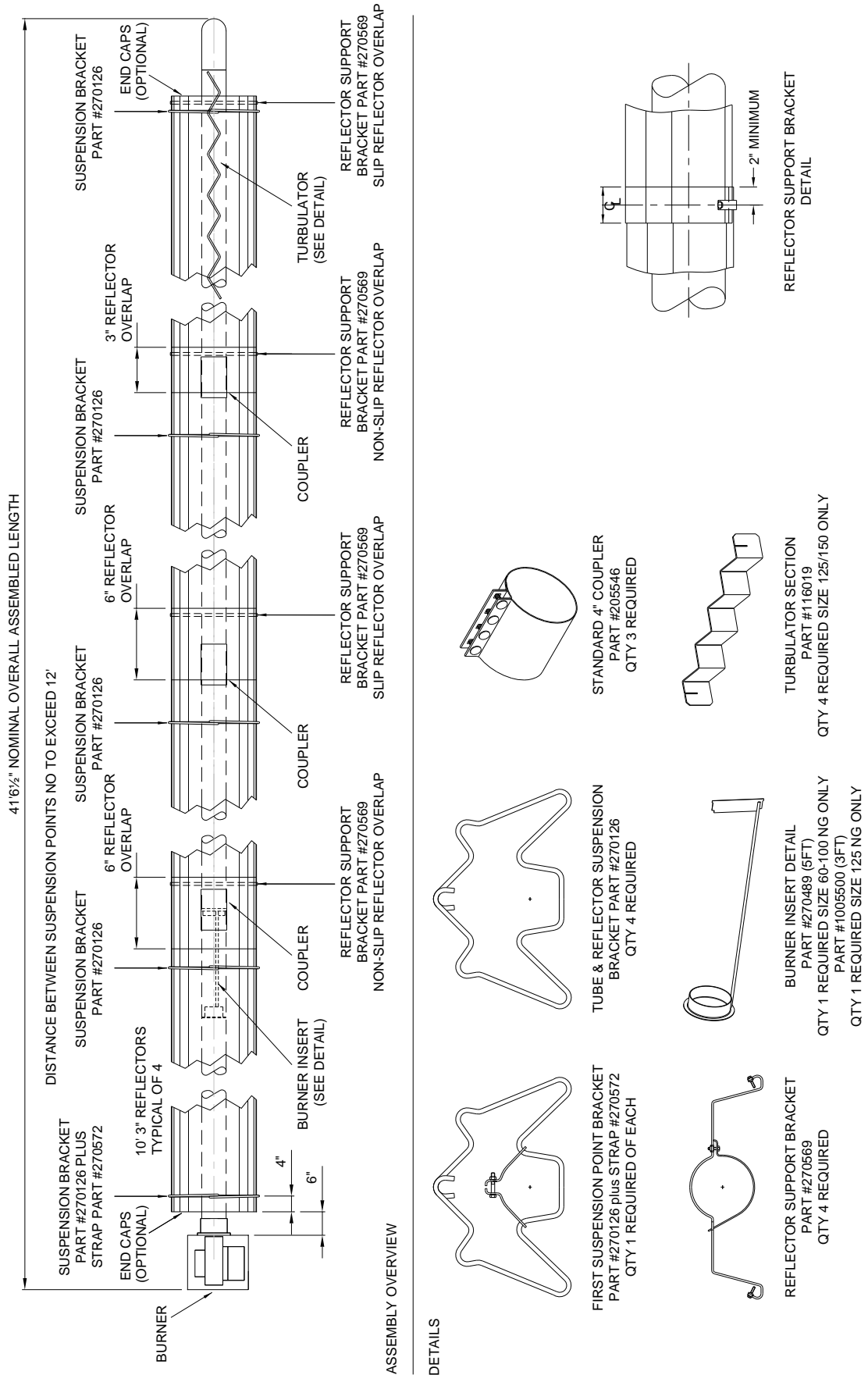
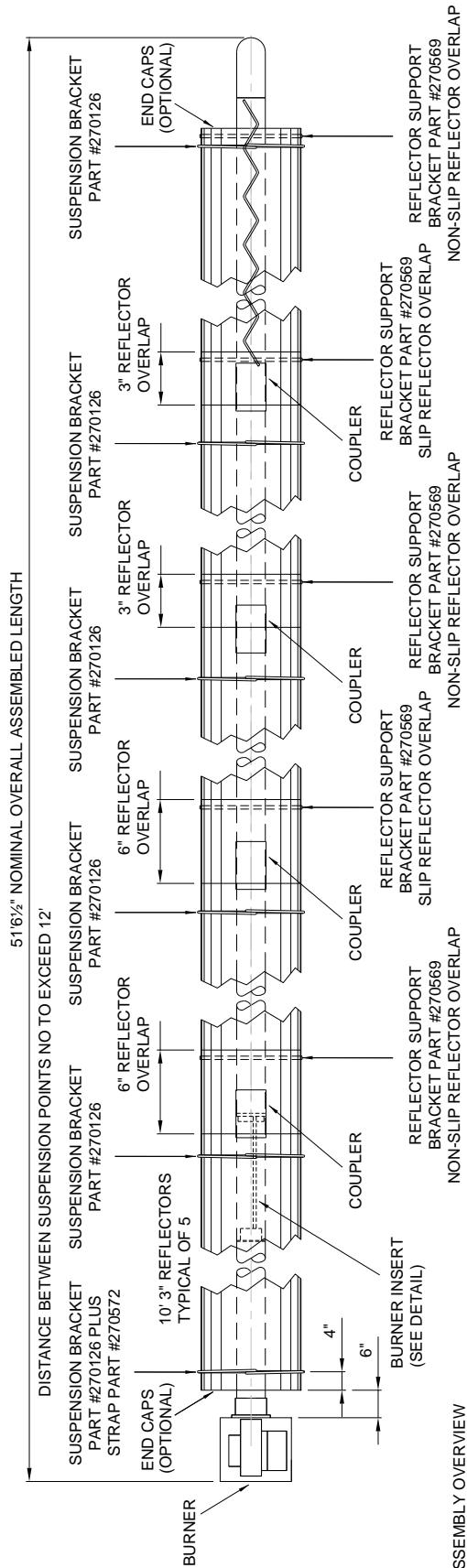
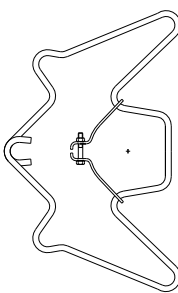


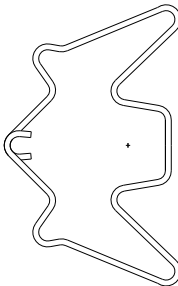
Figure 12. Heater Assembly: Model Linear 100-S50, 125-S50, 150-S50, 170-S50, and 200-S50



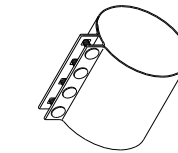
DETAILS



FIRST SUSPENSION POINT BRACKET  
PART #270126 plus STRAP #270572  
QTY 1 REQUIRED OF EACH

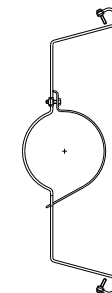


TUBE & REFLECTOR SUSPENSION  
BRACKET PART #270126  
QTY 5 REQUIRED

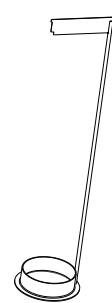


STANDARD 4" COUPLER  
PART #205546  
QTY 4 REQUIRED

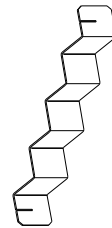
**NOTE: The 200 S50 model requires a different fan orifice plate. See P16 for details.**



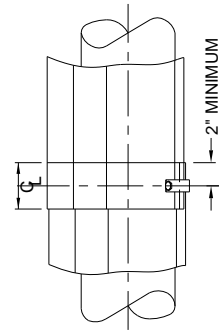
REFLECTOR SUPPORT BRACKET  
PART #270569  
QTY 5 REQUIRED



BURNER INSERT DETAIL  
PART #270489 (5FT)  
QTY 1 REQUIRED SIZE 100 NG ONLY  
PART #1005500 (3FT)  
QTY 1 REQUIRED SIZE 125 NG ONLY



TURBULATOR SECTION  
PART #116019  
QTY 4 REQUIRED SIZE 200 NG ONLY  
QTY 2 REQUIRED SIZE 170 LPG ONLY

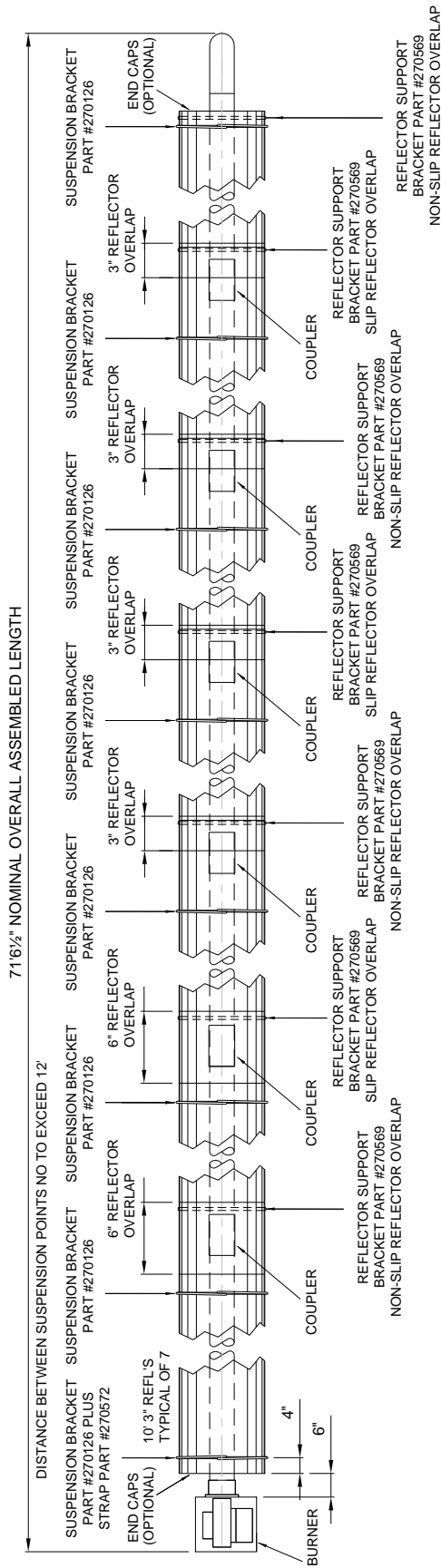


REFLECTOR SUPPORT BRACKET  
DETAIL



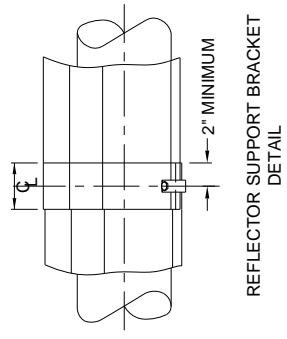
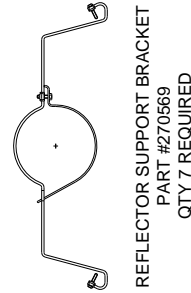
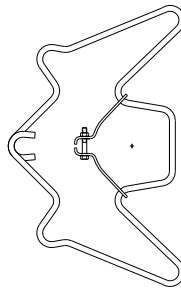
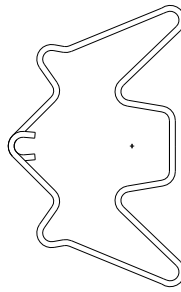
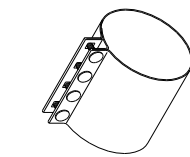


**Figure 14. Heater Assembly: Model Linear 150-S70, 170-S70 and 200-S70**



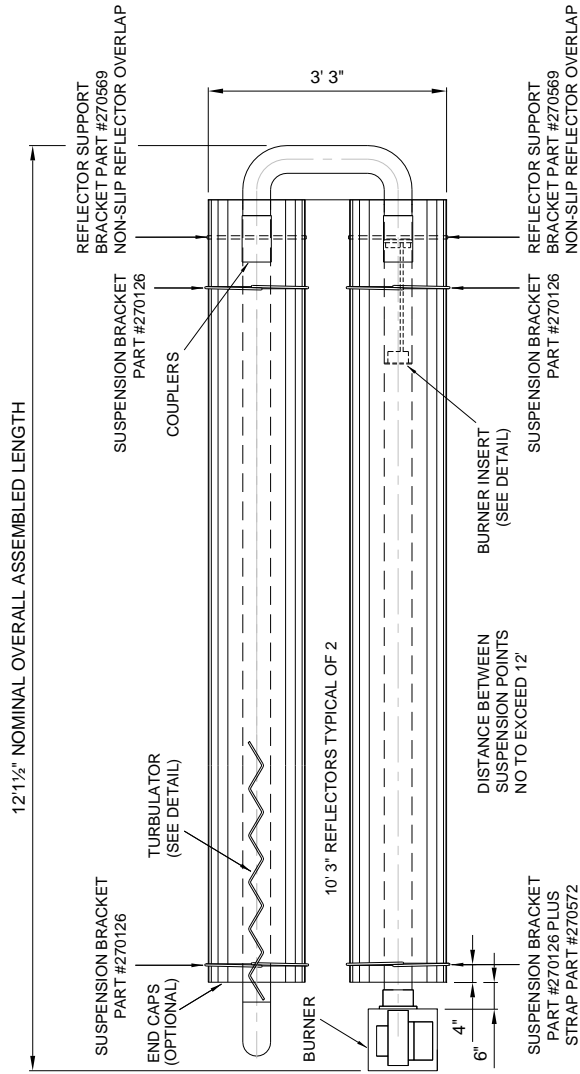
**ASSEMBLY OVERVIEW**

**DETAILS**



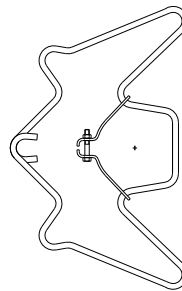


**Figure 16. Heater Assembly: Model U tube 60-U20 and 80-U20**

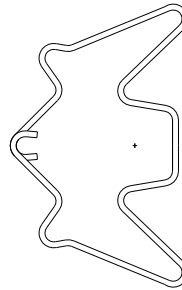


**ASSEMBLY OVERVIEW**

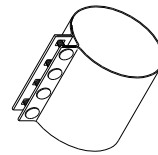
**DETAILS**



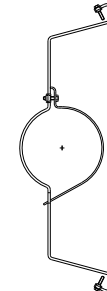
FIRST SUSPENSION POINT BRACKET  
PART #270126 plus STRAP #270572  
QTY 1 REQUIRED OF EACH



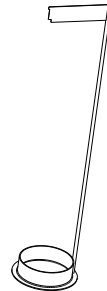
TUBE & REFLECTOR SUSPENSION  
BRACKET PART #270126  
QTY 3 REQUIRED



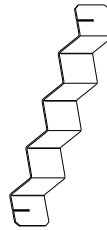
STANDARD 4" COUPLER  
PART #205546  
QTY 2 REQUIRED



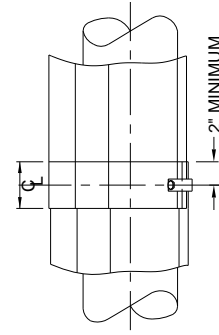
REFLECTOR SUPPORT BRACKET  
PART #270569  
QTY 2 REQUIRED



BURNER INSERT DETAIL  
PART #270489 (5FT)  
QTY 1 REQUIRED NAT GAS ONLY

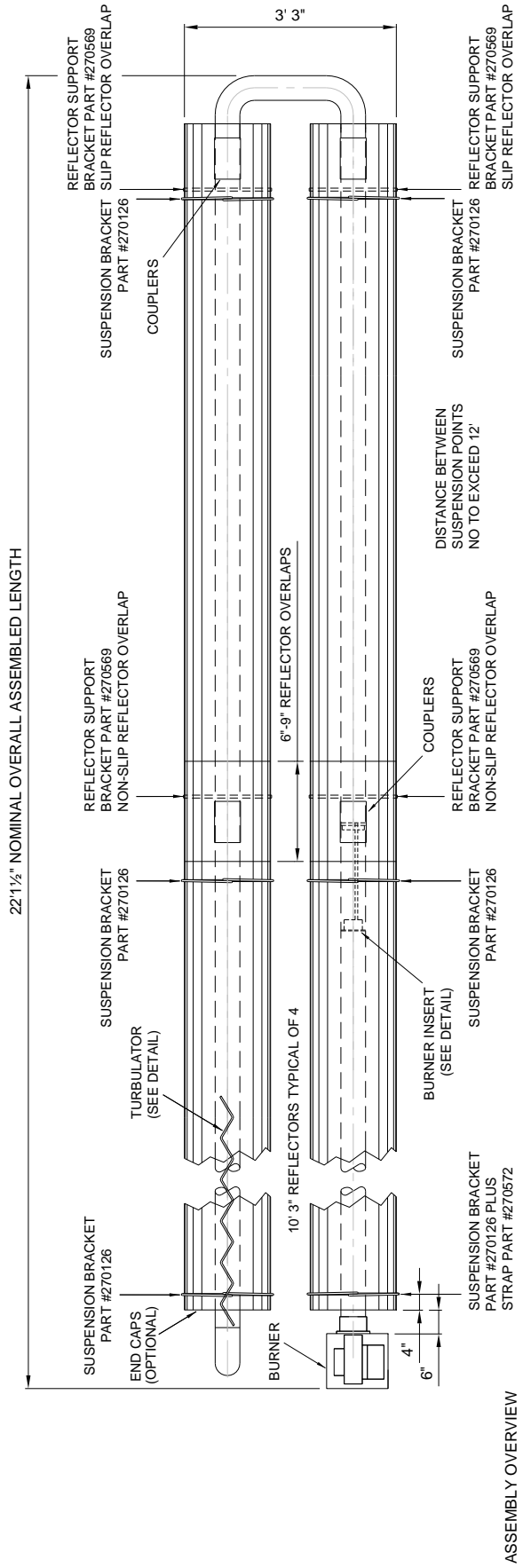


TURBULATOR SECTION  
PART #116019  
QTY 1 REQUIRED SIZE 60 ONLY  
QTY 3 REQUIRED SIZE 80 ONLY

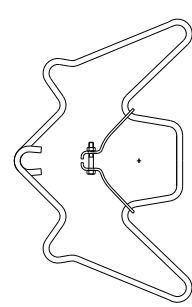


REFLECTOR SUPPORT BRACKET  
DETAIL

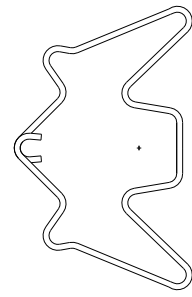
**Figure 17. Heater Assembly: Model U tube 60-U40, 80-U40, 100-U40, 125-U40 and 150-U40**



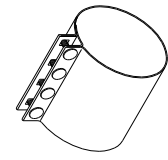
**DETAILS**



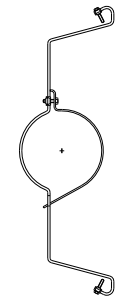
FIRST SUSPENSION POINT BRACKET  
PART #270126 plus STRAP #270572  
QTY 1 REQUIRED OF EACH



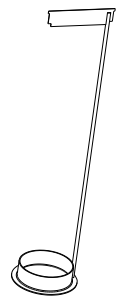
TUBE & REFLECTOR SUSPENSION  
BRACKET PART #270126  
QTY 5 REQUIRED



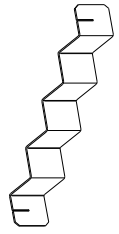
STANDARD 4" COUPLER  
PART #205546  
QTY 4 REQUIRED



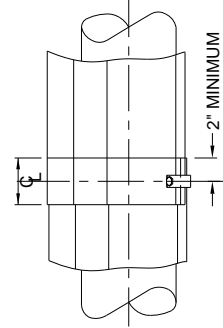
REFLECTOR SUPPORT BRACKET  
PART #270569  
QTY 4 REQUIRED



BURNER INSERT DETAIL  
PART #270489 (5FT)  
PART #1005500 (3FT)  
QTY 1 REQUIRED SIZE 60-100 NG ONLY  
QTY 1 REQUIRED SIZE 125 NG ONLY



TURBULATOR SECTION  
PART #116019  
QTY 4 REQUIRED SIZE 150 ONLY



REFLECTOR SUPPORT BRACKET  
DETAIL  
2" MINIMUM

**Figure 18. Heater Assembly: Model U tube 125-U60, 150-U60, 170-U60 and 200-U60**

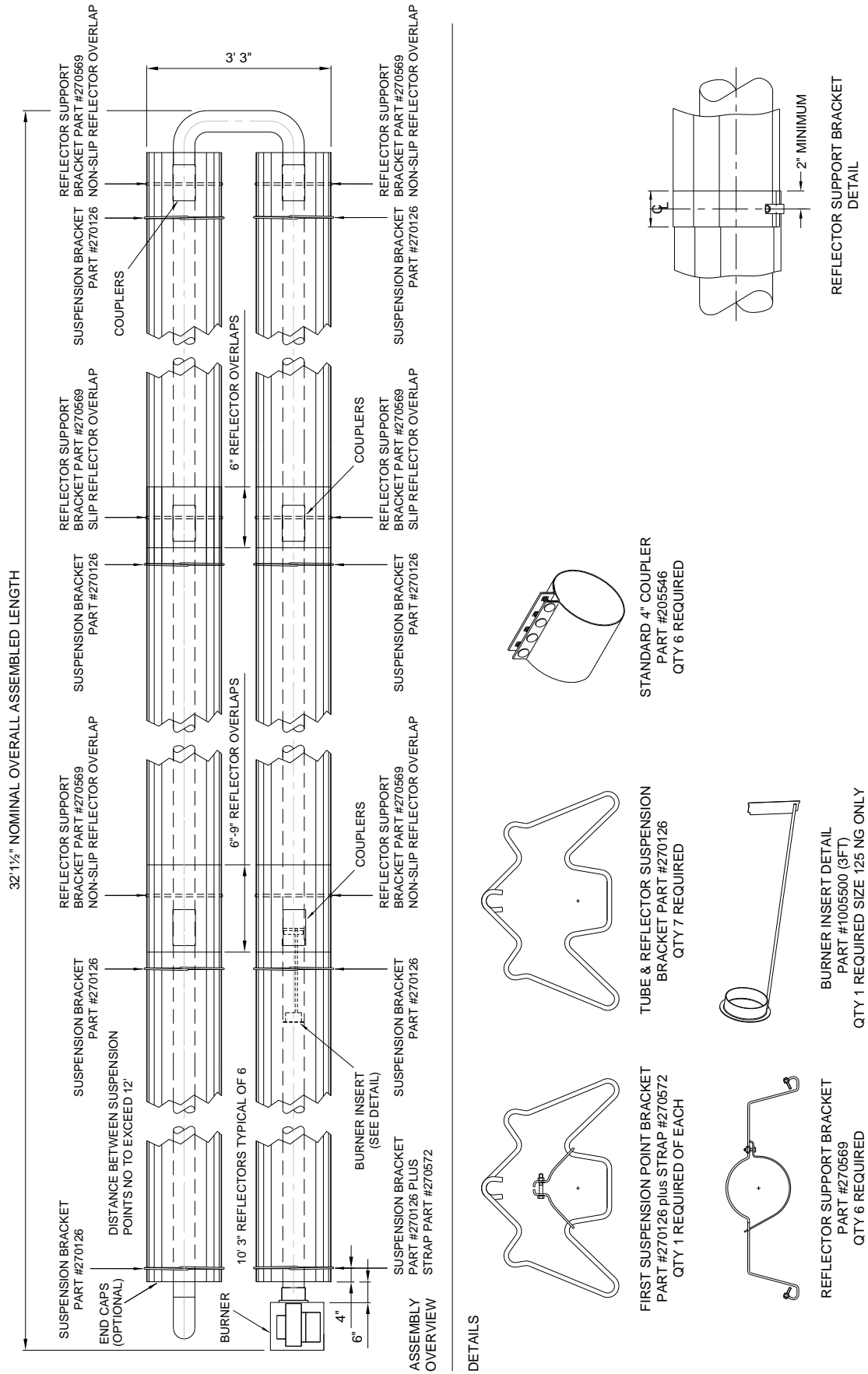
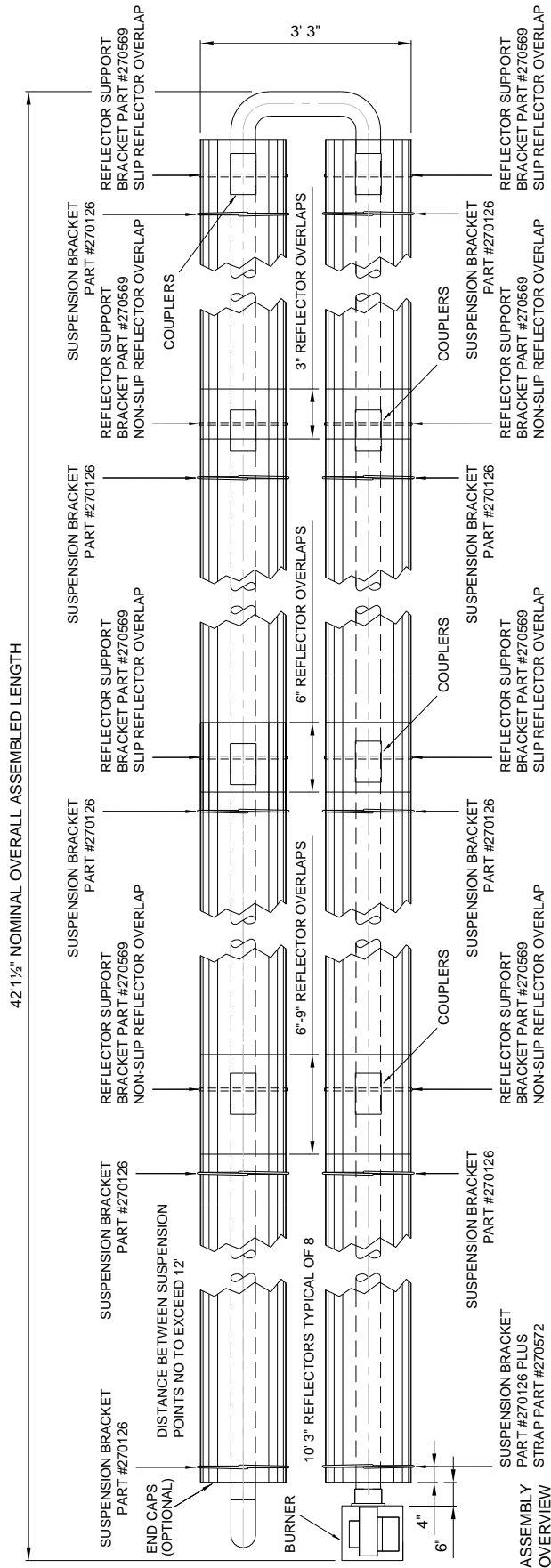
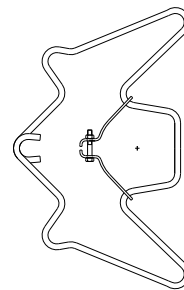


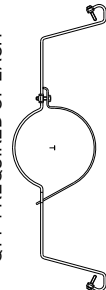
Figure 19. Heater Assembly: Model U tube 170-U80 and 200-U80



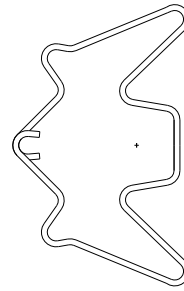
DETAILS



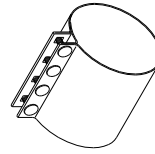
FIRST SUSPENSION POINT BRACKET  
PART #270126 plus STRAP #270572  
QTY 1 REQUIRED OF EACH



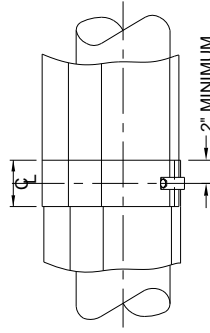
REFLECTOR SUPPORT BRACKET  
PART #270569  
QTY 8 REQUIRED



TUBE & REFLECTOR SUSPENSION  
BRACKET PART #270126  
QTY 9 REQUIRED



STANDARD 4" COUPLER  
PART #205546  
QTY 8 REQUIRED



REFLECTOR SUPPORT BRACKET  
DETAIL

## 3. Start Up Instructions.



**These appliances should be commissioned by a qualified mechanical contractor.**

### 3.1 Tools Required

The following tools and equipment are advisable to complete the tasks laid out in this manual.



**Suitable alternative tools may be used.**



**Leather Faced Gloves**



**Phillips Screwdriver**



**Small Flat Head Screwdriver**



**Large Adjustable Wrenches for fitting of Gas Flex**



**1/2" Wrench**



**5/32" (4mm) Allen Wrench**



**Manometer**



**Multimeter**

### 3.2 Start Up Procedure

Inspect installation and ensure that it has been carried out in accordance with these instructions. Ensure that electrical and gas supplies are isolated.

The gas supply should be purged and tested for leaks in accordance with local and National Safety codes.

Open shut off gas valve and test gas connections for leaks using soap solution.

Open the control housing door by unscrewing the securing screw. Ensure all internal components are securely fixed and all connections securely made.

Switch on the electrical supply to start the heater and observe the correct start up sequence. Ensure that the setting of any time clock and thermostat are such that the heating system will be required to operate.

The fan will start to run and the 'power on' lamp will illuminate. Safe-start checks are carried out automatically.

After the fan has run up to full speed and a satisfactory vent pressure condition has been established, the ignition sequence will commence. The spark ignition will be energized producing a spark at the ignition electrode. The gas solenoid valve will energize at the same time and the 'burner on' lamp will illuminate. If the ignition is successful, the flame is detected by the flame sensing probe and the 'burner on' lamp will remain on.

If ignition is unsuccessful, after approximately 15 seconds the gas valve will close and the spark ignition will de-energize.

For approximately 30 seconds the fan will purge the system, then re-ignition will be attempted. After 2 further attempts at ignition the control unit will 'lock-out', the 'power on' lamp will remain illuminated and the fan will run for 120 seconds and then stop.

To reset after 'lockout' switch off the power supply to the system and wait 2 minutes. Then turn the power on. If repeated 'lockout' occurs, investigate the cause.

Set burner gas pressure as follows:  
Switch off the power supply to the heating system.

Connect a 'U' tube or digital manometer to the pressure test point provided on the combination gas control valve.

Remove the cover from the pressure regulator to reveal the adjusting screw.

Start the heater and using a suitable screwdriver adjust the pressure regulator, turning the screw clockwise to increase the pressure or counter-clockwise to decrease the pressure.

Set the pressure to appropriate inches w.c. from the table of gas pressures and orifice plate dimensions for correct heater description. (See section 1.8 page 13)



To enable post purge ensure that the setting of any time switch and thermostat are such that the heating system will be required to turn off.

Switch off the power supply to the heating system. Disconnect manometer, then secure screw in pressure test nipple.

Check the operation of the flame safeguard equipment as follows:

With the heater running normally, switch off the gas supply at the shut off valve. The heater should attempt to relight then 'lock-out' should occur. This is indicated by the 'power on' lamp being illuminated and fan running, but the 'burner on' lamp being off.

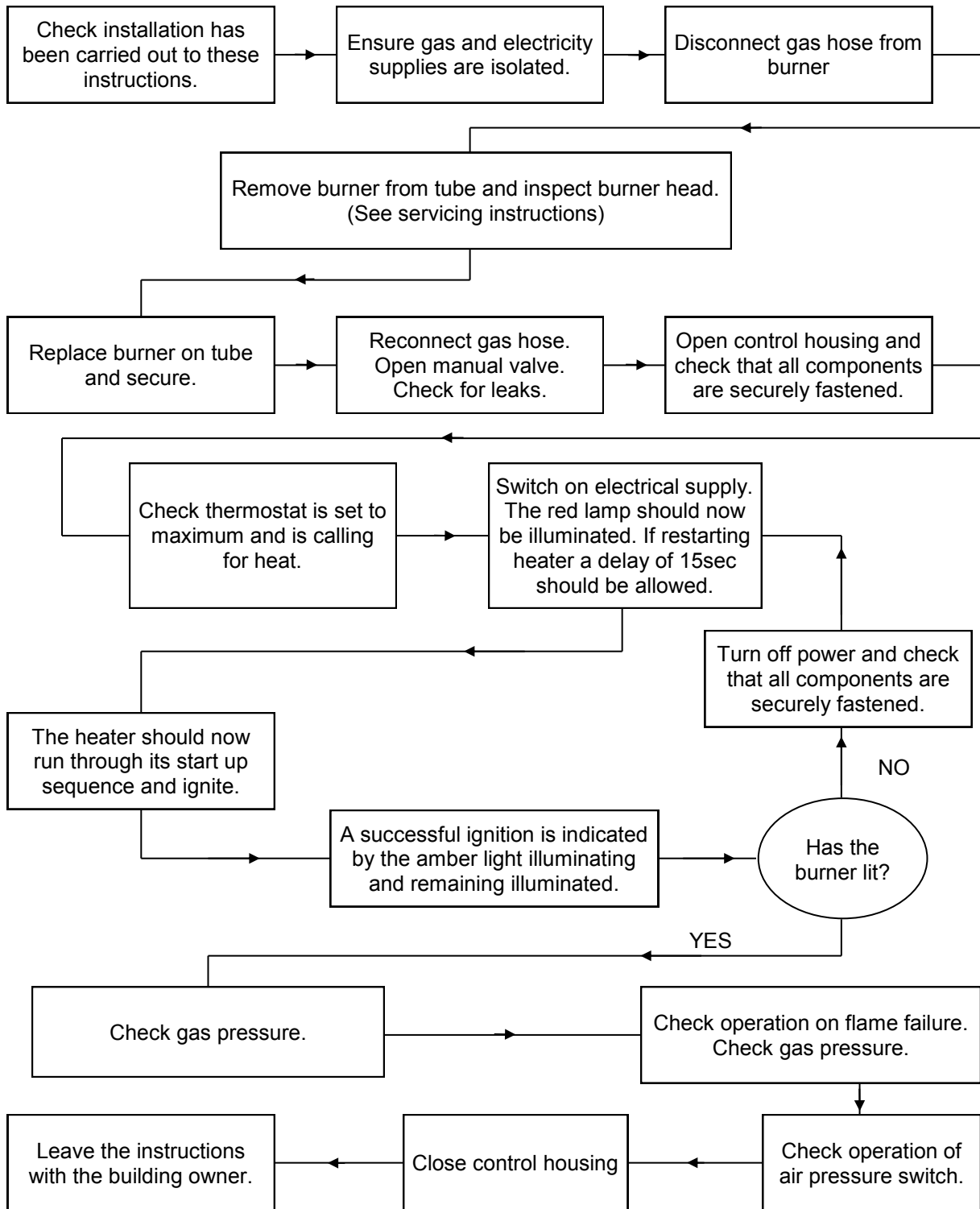
Check the operation of the pressure proving switch as follows:

With the heater running normally, pull off the silicone rubber tube connecting the vacuum switch to the combustion chamber. The burner should shut off within 4 seconds .

Replace the tube securely and observe that the heater proceeds to ignite in the normal way.

Close the controls door and secure with the screw.

**Commissioning chart**



# 4. Servicing Instructions.



These appliances should be serviced annually by a competent person to ensure safe and efficient operation. In mildly dusty or polluted conditions more frequent servicing may be required. Servicing work should be carried out by a qualified mechanical contractor.

## 4.1 Tools Required

to complete the tasks laid out in this manual.

The following tools and equipment are advisable



Suitable alternative tools may be used.



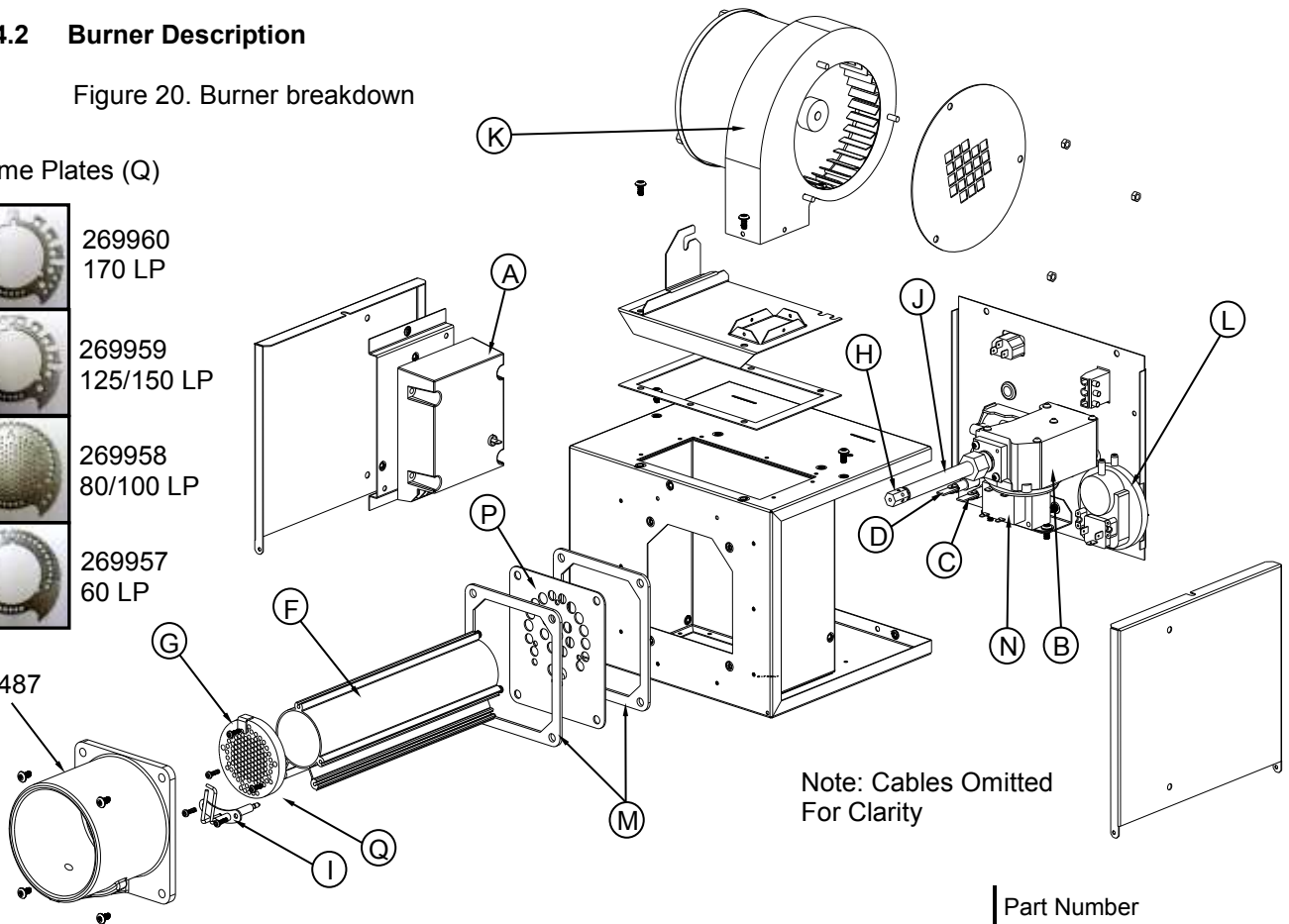
## 4.2 Burner Description

Figure 20. Burner breakdown

Flame Plates (Q)




270487

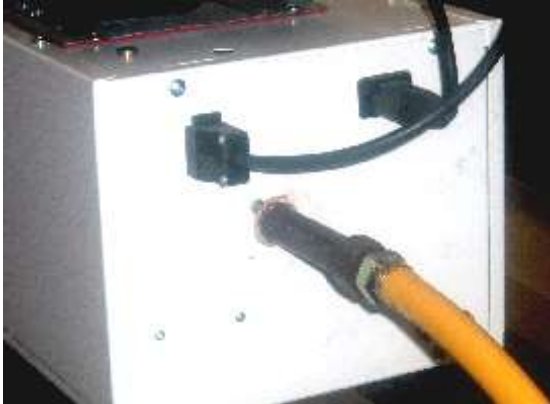


Note: Cables Omitted For Clarity

	Part Number	Part Number
A	Ignition Controller	204955
B	Gas Valve	270378 (NG) 270496 (LP)
C	Power On Red LED	270474
D	Burner On Amber LED	270473
F	Burner Tube	270424
G	Burner head	270425
H	Injector	See section 1.8 P13
I	Igniter Assembly	270441
J	Injector Carrier	See section 1.8 P13
K	Combustion Fan	See section 1.8 P13
L	Pressure Switch	See section 1.8 P13
M	Gaskets	2 off 270366
N	Transformer	175265
P	Burner Orifice Plate	See section 1.8 P13
Q	Flame Plate (not shown)	See photos above

### 4.3 Burner Removal

 **Step 1:** Isolate power and gas supplies.



**Step 2:** Unplug the power connectors.

**Step 3:** Detach the gas supply as shown below, taking care to support the burner connection.



**Step 4:** If fresh air is connected, slacken hose clip and remove the flexible hose from the burner.



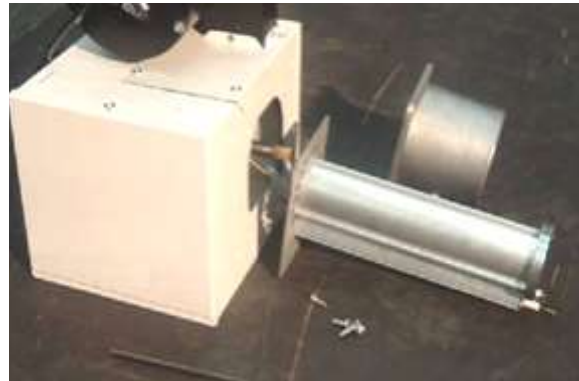
**Step 5:** Loosen the set screw on the burner support casting to enable the burner to be removed from the emitter tube.



**Step 6:** Remove the burner and position in a safe area to prevent the burner or components attached to the burner from falling to the ground.

### 4.4 Burner Gas Injector Servicing

**Step 1:** Remove the burner support casting and gasket.




**Step 2:** The burner head assembly can be disconnected by separating the connectors of the ignition lead, ground lead assembly and removing the pressure switch silicon tube.



**Step 3:** The gas injector can be inspected and replaced if contaminated or blocked.



 When replacing the gas injector ensure approved thread sealant is used.

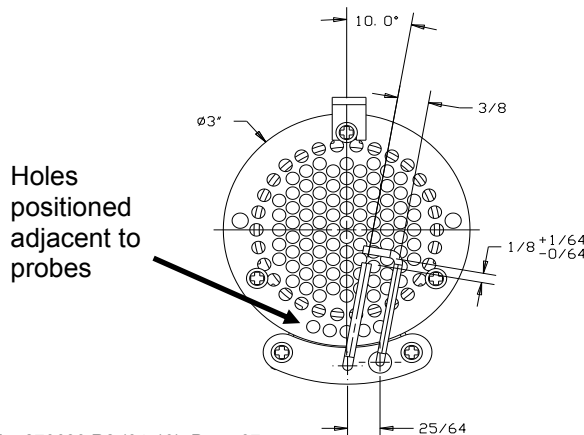
**Step 4:** Reconnect ignition leads, ground lead and silicone tube to test nipple. Refit gasket and support casting.

#### 4.5 Burner Head and Electrode Servicing

**Step 1:** Check the pepper pot burner head for contamination. If necessary this can be removed, see picture below. It can be cleaned together with the Inside of the burner head.



**Step 2:** The pepper pot burner head can be replaced ensuring the 5 outer holes are aligned alongside the probes. (See diagram below).



**Step 3:** The condition of the igniter assembly can be checked for deterioration. However, we advise replacement at each service to ensure continued reliability. Detach the electrode assembly from the burner head by removing the two screws and separating the igniter lead connectors.



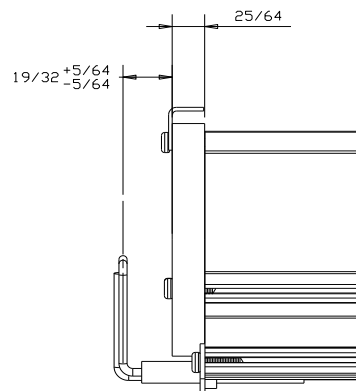
**Step 4:** Refit the electrode assembly and ensure the connections are secure to prevent incorrect sparking .

**Step 5:** Check the positions and spark gap as shown below.

**Step 6:** The burner assembly is ready to refit after servicing the combustion fan and the radiant tube assembly.

#### 4.6 Combustion Fan Assembly

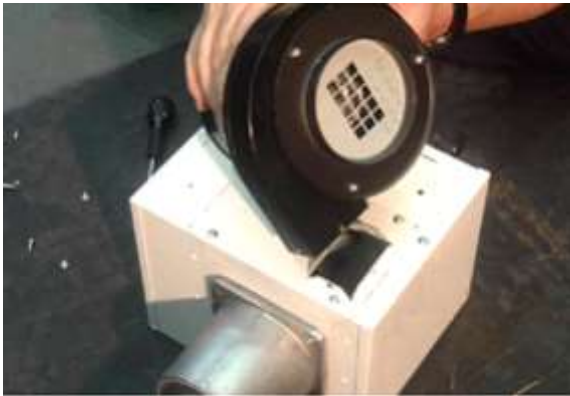
**Step 1:** If ducted air is fitted, loosen hose clamp and remove the flexible hose from the fan.



**Step 2:** Remove fan retaining screws and unplug from burner box.



**Step 3:** The combustion fan can now be detached.



**Step 4:** Remove the fan orifice plate and ducted air connection (if fitted).

**Step 5:** Inspect the impeller and remove any dust with a soft brush.

**Step 6:** Remove any dust from fan scroll and from around the motor.

**Step 7:** Ensure the impeller rotates freely.

**Step 8:** Refit components.

#### 4.7 Emitter Tube Servicing

**Step 1:** Brush any dust from the exterior of the emitter tubes.

**Step 2:** Visually inspect inside the emitter tubes. If they are clean, skip to servicing the reflector.

**Step 3:** If required the interior of the emitter tubes can then be cleaned using an industrial vacuum cleaner, or by using long poles and a scraper.

#### 4.8 Reflector Servicing

The condition of the reflectors should be noted. If necessary the reflectors can be cleaned with a mild detergent. This can significantly improve the efficiency of the appliance.

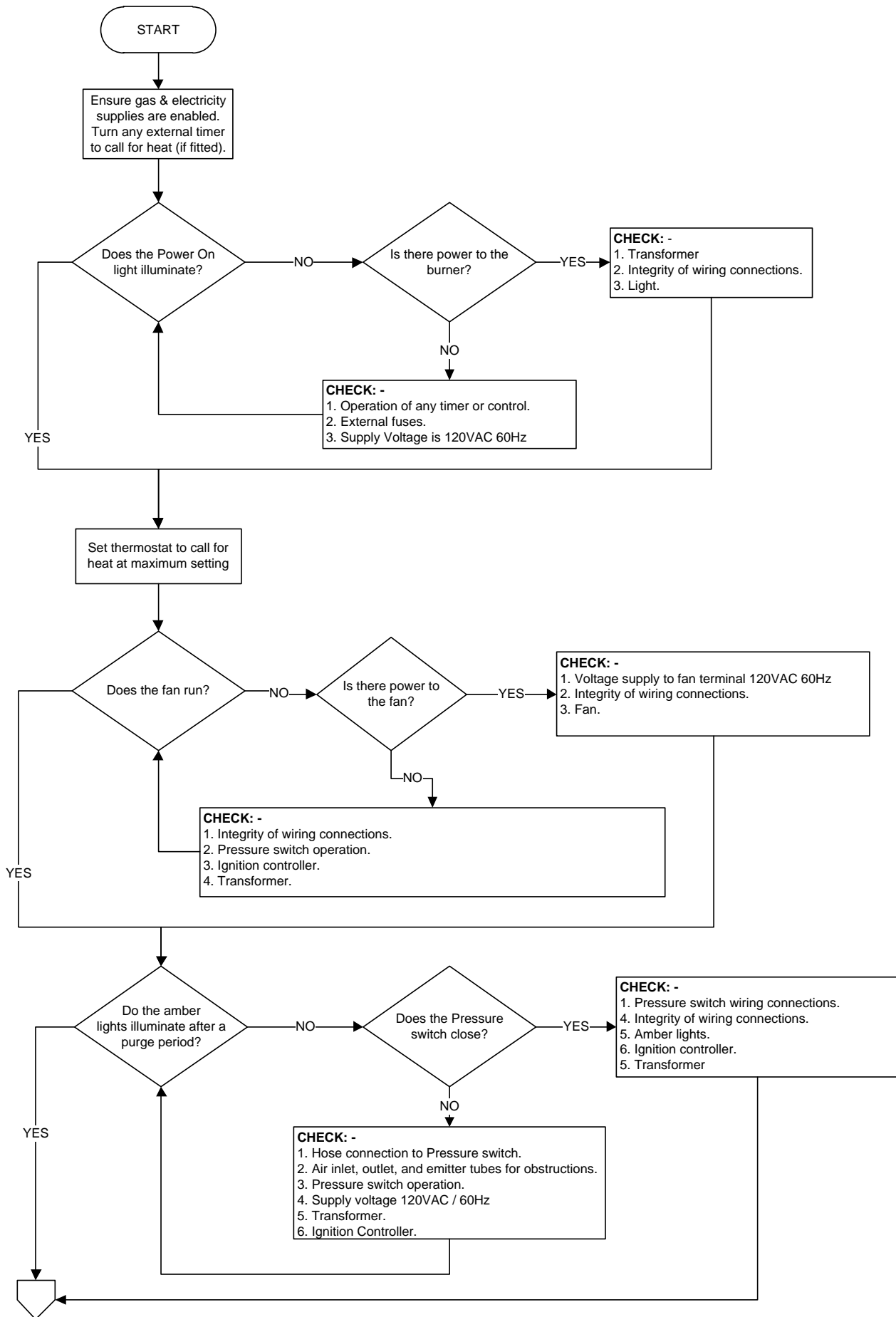
#### 4.9 Cleaning of Vent

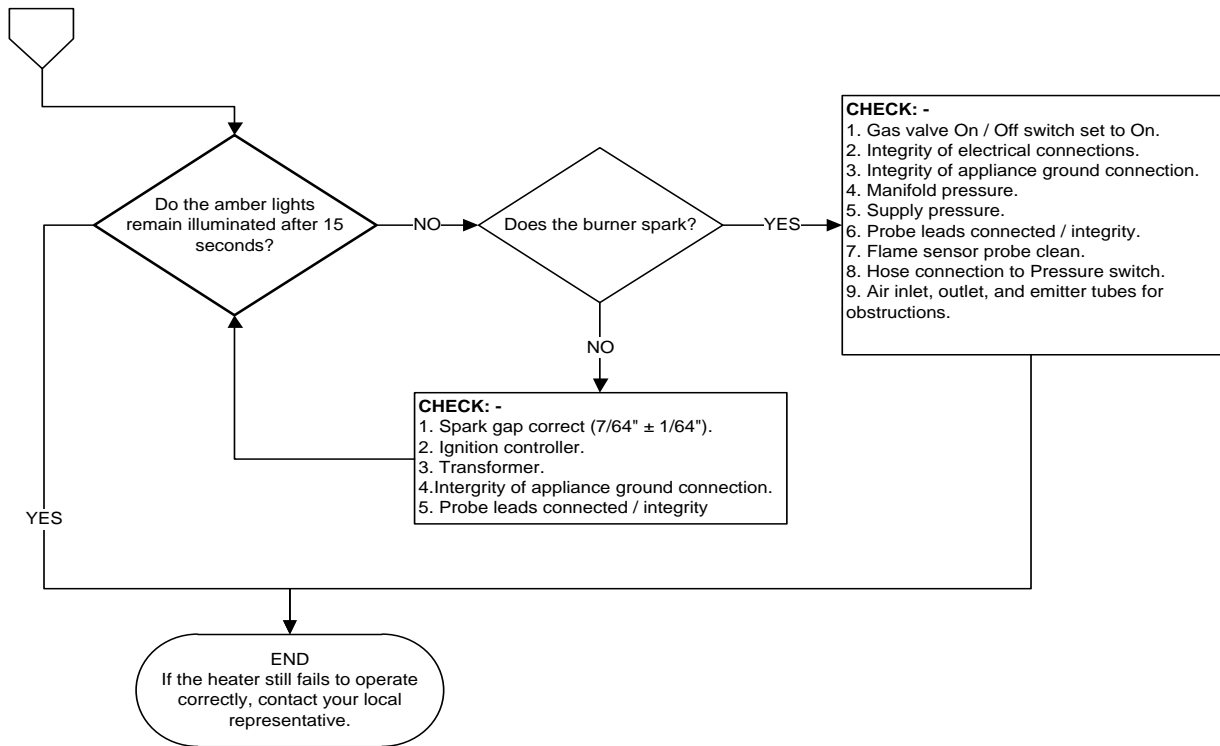
Inspect the fresh air inlet duct and vent to ensure they are free from any blockage or obstruction. The air inlet terminal and vent terminal should be inspected to ensure they are not liable to obstruction.

#### 4.10 Re-commissioning After Service

After servicing has been undertaken, it will be necessary to re-commission the heater as detailed in Section 3 of these instructions.

# 5. Troubleshooting Guide.





**To aid the troubleshooting process, the UT controller has a LED flash code diagnostic sequence:**

- Steady Off** No control power
- Steady On** Power applied, control OK
- 1 Flash** Combustion pressure switch open with blower on
- 2 Flashes** Combustion pressure switch closed with blower off
- 3 Flashes** Lockout from the three ignition trials
- 4 Flashes** Lockout from five flame losses
- 5 Flashes** Control hardware fault detected
- 6 Flashes** Lockout from five pressure switch losses



## 6. Replacing Parts.



Turn off gas and any electrical supplies to the heater before starting repair work.

### 6.1 Burner Controller Replacement

**Step 1:** Loosen screw in right hand burner access door and open.

**Step 2:** Disconnect burner controller from the wiring harness.



**Step 3:** Disconnect the spark lead from burner controller.



**Step 4:** Remove the two screws attaching the controller to the burner door and remove.



**Step 5:** Attach new burner controller.

**Step 6:** Re-attach leads.

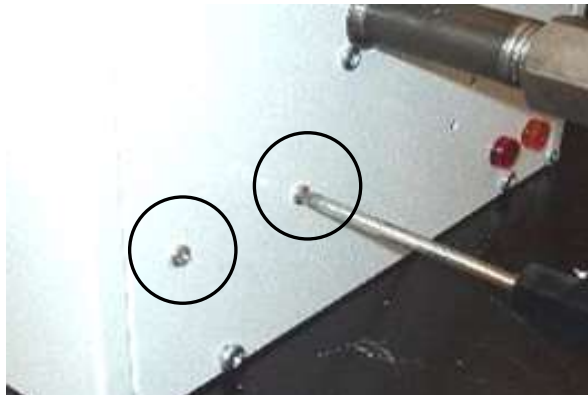
**Step 7:** Test product and close access door.

### 6.2 Air Pressure Switch Replacement

**Step 1:** Open left hand door. Disconnect the two silicone tubes from the pressure switch.



**Step 2:** Remove the two screws shown below.



**Step 3:** Remove electrical connections. The air pressure switch can now be removed.

**Step 4:** Fit the new air pressure switch ensuring the silicone tubes are connected as shown below.



**Step 5:** Test product and close access doors.

### 6.3 Gas Valve Replacement

**Step 1:** Remove the burner assembly as described in the servicing section.

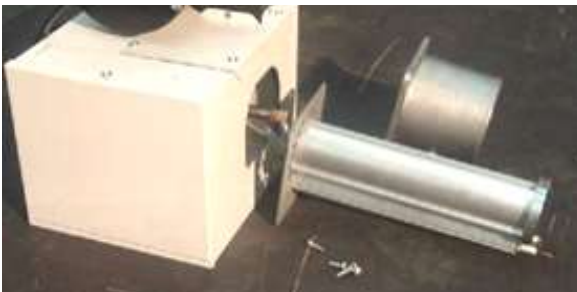
**Step 2:** Open the right hand access door and detach the burner controller from the wiring harness.



**Step 3:** Open the left hand access door and detach the silicone hoses from the air pressure switch.



**Step 4:** Remove the 4 screws holding the burner head onto the burner assembly.



**Step 5:** The burner head can now be detached by disconnecting the silicone tube and the burner head wiring.



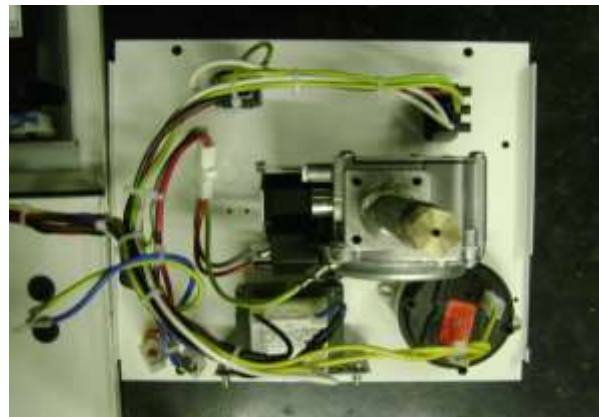
**Step 6:** Detach the two screws securing the front of the gas valve.



**Step 7:** Remove the four screws (arrowed), holding the rear burner plate in position.



**Step 8:** Remove the rear plate.



**Step 9:** The jet carrier, gas inlet, and wiring harness can now be detached from the gas valve.

**Step 10:** The two screws retaining the gas valve can now be removed.

**Step 11:** The gas valve can now be replaced.

**Step 12:** Reattach all components.

**Step 13:** Set pressures and test for reliable burner performance.

**Step 14:** Close access door.

Notes.



## 7. User & Operating Instructions

Radiant tubular infrared heaters are designed for overhead heating of industrial and commercial buildings. Individual heating units are suspended from the roof.



- 1. This appliance must only be installed by qualified installer in accordance with the requirements of local and National Codes.**
- 2. This appliance must be grounded in accordance with the National Electrical Code ANSI/NFPA No.70 or Canadian Codes.**
- 3. Never rest anything, especially ladders against the heaters.**

### 7.1 To Start the Heater

1. First ensure that the gas supply to each heater is turned on by opening the main gas shut off valve.
2. Ensure that the setting of any time clock and thermostat are such that the heating system will be required to operate.
3. Switch on the electricity supply to the heater. The fan will start, the 'power on' light on the burner will illuminate and ignition commence.
4. Ignition will occur.
5. If ignition is unsuccessful the gas valve will close and the spark ignition de-energize after approximately 15 seconds. For approximately 30 seconds the fan will purge the system then re-ignition will be attempted. After 3 attempts at ignition the control unit will 'lock-out', the 'power on' lamp will remain illuminated and the fan will

continue to run for 120 seconds and then stop. To reset after 'lockout', switch off the power supply to the heater and wait 5 minutes. Then turn the power on. If repeated 'lockout' occurs investigate the cause.

### 7.2. To Switch Off Heater

Ensure that the setting of any time switch and thermostat are such that the heating system will be required to turn off. Switch off electrical supply to the heater. The burner will stop and the fan will shut off.

### 7.3. Servicing

To ensure continued, efficient and safe operation it is recommended that the heater be serviced regularly by a qualified person every year in normal working environments, but in exceptionally dusty or polluted environments more frequent servicing may be needed.