

Condensing low-emission gas-fired air heater

ULSA

025(EC), 035(EC), 050(EC),
075(EC), 100(EC)



size 050

This appliance meets the following EC Directives

DIR 2009/142/EC : GAD

DIR 2014/30/EU : EMC

DIR 2014/35/EU : LVD

DIR 2006/42/EC : MD

INSTALLATION – COMMISSIONING – SERVICING – USER - INSTRUCTIONS

Applies to :

Belarus, Bulgaria, China, Czech Republic, Croatia, Cyprus, Denmark, Estonia, Finland, Greece, Hungary, Iceland, Latvia, Lithuania, Montenegro, New Zealand, Norway, Poland, Portugal, Romania, Russian Federation, Serbia, Slovakia, Slovenia, South Africa, Spain, Sweden, Turkey, Ukraine

Please read this document carefully before commencing the installation and leave it with the user or attached to the appliance or gas service meter after installation!

ATTENTION

The manufacturer does not take any responsibility in the event of non-observance of the regulation concerning the connection of the apparatus causing a harmful operation possibly resulting in damage to the apparatus and/or environment in which the unit is installed.

Subject to modifications

 **NORTEK™**
GLOBAL HVAC

TABLE OF CONTENTS

1	Hazard intensity levels	2
2	General	3
	Warnings	3
	General	4
	Warranty	4
	Uncrating & preparation	4
	Heater location	5
3	Technical data	6
4	Dimensions & clearances	8
5	Internal lay-out	10
6	Installing	11
7	Air supply & flue systems	12
8	Condensation drain pipe connection	16
9	Gas connection/Gas supply	17
10	Electrical connections	19
11	Commissioning, lighting & operation	21
12	Maintenance	23
13	Fault finding	25
14	Spare parts list	27
15	User instructions	27
16	Declaration of conformity	29

1. HAZARD INTENSITY LEVELS



DANGER

Failure to comply will result in severe personal injury or death and/or property damage.



WARNING

Failure to comply could result in severe personal injury or death and/or property damage.



CAUTION

Failure to comply could result in minor personal injury and/or property damage.

2. GENERAL

2.1 WARNINGS



- For your safety, if you smell gas :
 - Do not try to light any appliance
 - Do not touch any electrical switch, do not use any phone in your building
 - Evacuate all personnel
 - Contact your gas supplier immediately
- Do not store or use petrol or other flammable vapours and liquids in the vicinity of the appliance.
- Improper installation, adjustment, alteration, service or maintenance can cause property damage, injury or death. Read the installation, operation and maintenance instructions thoroughly before installing or servicing this equipment.
- Do not use this appliance if any part has been immersed in water. Immediately call a qualified service technician to inspect the appliance and replace any gas control that has been immersed in water.
- This appliance is not intended for use by persons (including children) with reduced sensory or mental capacities or lack of experience and knowledge unless they have been given supervision or instructions concerning use of the appliance by a person responsible for their safety.
Children should be supervised to ensure that they do not play with the appliance.
- Should overheating occur or the gas supply fails to shut off, shut off the manual gas valve to the appliance before shutting off the electrical supply.
- Gas-fired appliances are not designed for use in hazardous atmospheres containing flammable vapours or combustible dust, in atmospheres containing chlorinated or halogenated hydrocarbons or in appliances with airborne silicone substances.
- The manual should be kept in a safe place for future reference.
- Unauthorised modification of this appliance or departure from use in the manner, for which it was intended by the manufacturer or installed in a manner contrary to these instructions, may constitute a hazard and jeopardize all warranties.
Deviations should only be carried out after formal consent has been obtained from the manufacturer.
- Use only factory-authorized parts when replacement is required.
- In case of persisting problems, contact your distributor

2.2 GENERAL

- The instructions in this manual apply to the condensing gas-fired air heater model ULSA/ULSA EC. All models and sizes are available for use with either natural, propane or butane gas within operating temperatures between -15°C and 40°C.
- These heaters are designed for use in domestic, industrial and commercial premises, suitable only for indoor installation
- The type of gas, the input rate and the electrical supply requirements are shown on the heater rating plate.
- The instructions are only valid for the country of use indicated on the appliance. If not correct contact your supplier.
- Installation should be done by a suitably qualified installer in accordance with these instructions and with all rules in force.
- The installation manual is shipped with the heater. Verify that the literature is correct for the heater being installed. If the manual is incorrect for the heater, contact the supplier before beginning installation.
- Ensure the environment in which the air heater will be installed will not create a hazard i.e. where excessive dust, flammable or corrosive substances and/or vapours and combustible materials may be present.

2.3 WARRANTY



Warranty is void if :

- Heaters are used in atmospheres containing flammable vapours or atmospheres containing chlorinated or halogenated hydrocarbons or any contaminant (silicone, aluminium oxide, etc ...).
- The installation is not in accordance with these instructions.
- Wiring is not in accordance with the diagram furnished with the heater.
- Unit is installed without proper clearance to combustible materials or without proper ventilation and air for combustion.
- Air throughput is not adjusted within the range specified on the rating plate.

2.4 UNCRATING & PREPARATION

- The unit was test operated and inspected at the factory prior to crating and was in proper operating condition. If the heater has incurred damage in shipment, document the damage with the transport company and contact your supplier. Before installation check that the appliance as described on the packaging label is in accordance with the correct type and model as specified on the data plate and complies with your customer order. After unpacking the appliance, leave it fastened to any base packing for transportation until it has been suspended or until just before base mounting. This affords protection to the underside.
- Check the rating plate to determine if the heater is appropriate for the intended installation.
- Read the manual thoroughly and become familiar with the installation requirements of your heater. If you do not have knowledge of local requirements, check with the gas supplier and any other local agencies that might have requirements concerning this installation.
- Before beginning make preparations for necessary supplies, tools and manpower. If the installation includes optional parts, install these options before the heater is suspended. Follow the instructions included in the option package.

2.5 HEATER LOCATION

Attention Flue requirements may affect location. Consult section 7 before making a final determination.

- Use the minimum clearances as illustrated in figure 2 and the throw data mentioned in table 1 (Technical Data) to define where to locate the heater.
- Also respect the recommended minimum height as given in table 1.
- For best results, the heater should be placed with certain rules in mind. Always ensure that minimum clearances are maintained. Locating a unit heater above the maximum recommended height can result in significant air stratification. When possible, heaters should be arranged to blow toward or along exposed wall surfaces.
- Suspended heaters are most effective when located as close to the working zone as possible, but care should be exercised to avoid directing the discharged air directly on to the room occupants.
- Partitions, columns, counters or other obstructions should be taken into consideration when locating the unit heater so that a minimum quantity of airflow will be deflected by such obstacles.
- When units are located in the centre of the space to be heated, the air should be discharged toward the exposed walls. In large areas, units should be located to discharge air along exposed walls with extra units provided to discharge air towards the centre of the area. For optimum results heaters are best used in conjunction with recirculating air fans suspended at high level.
- At those points where infiltration of cold air is excessive, such as entrance doors ... it is desirable to locate the unit so that it will discharge directly towards the source of cold air, typically from a distance of 4.5m to 6m or install a downflown unit over the door opening.



WARNING

If touched, the vent pipe and internal heater surfaces that are accessible from outside the heater will cause burns. Suspend the heater so that these components cannot be touched !



CAUTION

Do not locate the heater where it may be exposed to water.

Attention
Hazards of chlorine apply to the location of the combustion air inlet

The presence of chlorine vapours in the combustion air of gas-fired heating equipment presents a potential corrosion hazard. Care should be taken to separate these vapours from the combustion process. This may be done by wise location of the unit flue and combustion air terminals with regard to exhausters or prevailing wind directions. Chlorine is heavier than air. Keep this fact in mind when determining installation location of the heater in relation to building exhaust systems. Where chlorine vapours are prevalent, heaters with special grade 316 AISI stainless steel heat exchangers are recommended.

3. TECHNICAL DATA

Table 1a

ULSA/ULSA EC			025	035	050	075	100
Gas category		Cat.	See table 1b				
Comb. air & flue, type B instal (1)			B22p				
Comb. air & flue, type c instal (1)			C12, C32, C42, C52, C62, C82				
Maximum heat input (Hs)		kW	28,3	37,0	56,0	78,4	106,3
Maximum heat input (Hi)		kW	25,5	33,3	50,4	70,6	95,7
Minimum heat input (Hs)		kW	5,7	7,2	11,4	15,9	20,9
Minimum heat input (Hi)		kW	5,2	6,5	10,3	14,3	18,9
Maximum heat output		kW	25,0	32,7	49,4	69,2	93,8
Minimum heat output		kW	5,5	7,0	11,0	15,3	20,2
Max thermal efficiency at max heat input (G20)		%	98,30	98,00	98,60	98,60	98,60
Max thermal efficiency at min heat input (G20)		%	109,20	108,80	108,70	106,50	108,90
CO ₂ gas at max heat input	Nat gas G20 (H)	vol %	8,43	8,42	8,44	8,42	8,42
	Prop G31	vol %	9,81	9,81	9,81	9,80	9,80
Propane restrictor diameter		mm	3,4	6	6	6	6
Gas consumption at maximum heat input	Nat gas G20 (H)	m ³ /h	2,59	3,39	5,07	7,27	9,76
	Prop G31	kg/h	1,99	2,6	3,93	5,51	7,47
Gas consumption at minimum heat input	Nat gas G20 (H)	m ³ /h	0,55	0,69	1,09	1,52	2,00
	Prop G31	kg/h	0,4	0,51	0,8	1,12	1,47
Inlet pressures	Nat gas G20 (H)	mbar	See table 1b				
	Prop G31	mbar	See table 1b				
Air volume (15°C)		m ³ /h	2900	3700	5600	7900	10500
Temperature rise at max load		K	25	26	26	26	26
Horizontal throw (4)		m	20	23	30	30	36
Sound pressure level Lp (5) (AC)		dB(A)	47	51	55	53	58
Max sound pressure level Lp (5) (EC)		dB(A)	44	49	52	47	58
Min sound pressure level Lp (5) (EC)		dB(A)	38	34	35	35	40
Noise free field conditions(max) (EC)		dB(A)	37	42	45	40	51
Noise free field conditions (min) (EC)		dB(A)	31	27	28	28	33
Maximum absorbed power (AC)		W	290	320	690	750	1250
Maximum absorbed power (EC)		W	200	300	500	600	1.240
Gas connection (2)			Ø 1/2" G		Ø 3/4" G		
Electrical connection			230/240 V 1N-50Hz				
Connection diameter for flue gas and combustion air		mm	80	80	80	100	100
Condensation connection/outlet			Ø 32				
Condensate quantity		l/h	1,3	1,5	2	2,5	3,5
Recommended mounting height (3)		m	3	3,5	3,5	4	4
Weight		kg	120	129	147	199	231
Protection grade		IP	IP 20				
Revolutions per minute		rpm	950	1260	1340	820	1400
CE Approval number		PIN	0461CO1016				

(1)Gas Appliance Classifications for Approved Venting Methods based on CEN-report CR1749:2001

(2)Gas connection size is not necessarily the supply line size. There is a difference between the gas connection diameter and the diameter of the supply line. Always use the most adequate dia of the supply line to minimize the pressure drop through the gas pipes – if necessary reduce the diameter of the supply line at the inlet of the unit.

(3)Height from the floor to bottom surface of heater. These are recommendations only. Positioning of unit heaters for proper performance is application dependent. Operation is affected by other air moving equipment in the space, obstructions to the airflow, draughts and/or close proximity to doors or windows, etc... Care should be taken to avoid mounting the heaters above these recommendations, unless downturn nozzle options are used, as significant stratification may occur resulting in poor floor coverage and higher energy losses through the roof structure.

(4)Isothermal conditions at 20°C ambient air temperature, discharge louvre zero deflection, v = 0,5 m/s.

(5)Sound pressure level in dB(A) : measured at 5 meters from the unit with A=160m² & Q=2

Table 1b : Gas category & inlet pressures

country	gas cat G20	inlet pressure (mm)	gas cat G31	inlet pressure (mm)
Belarus	I2H	20	I3P	37
Bulgaria	I2H	20	I3P	37
China	I2H	20	I3P	37
Czech Republic	I2H	20	I3P	37
Croatia	I2H	20	I3P	37
Cyprus	I2H	20	I3B/P	30
Denmark	I2H	20	I3B/P	30
Estonia	I2H	20	I3B/P	30
Finland	I2H	20	I3B/P	30
Greece	I2H	20	I3P	37
Hungary	I2H	20	I3B/P	50
Iceland	I2H	20	I3P	37
Latvia	I2H	20	I3P	37
Lithuania	I2H	20	I3P	37
Montenegro	I2H	20	I3P	37
New Zealand	I2H	20	I3P	37
Norway	I2H	20	I3B/P	30
Poland	I2E	20	I3B/P	30
Portugal	I2H	20	I3P	37
Romania	I2E	20	I3B/P	30
Russian Federation	I2H	20	I3P	37
Serbia	I2H	20	I3P	37
Slovakia	I2H	20	I3P	37
Slovenia	I2H	20	I3P	37
South Africa	I2H	20	I3P	37
Spain	I2H	20	I3P	37
Sweden	I2H	20	I3B/P	30
Turkey	I2H	20	I3P	37
Ukraine	I2H	20	I3P	37

4. DIMENSIONS & CLEARANCES

4.1 DIMENSIONS

► Figure 1a :ULSA/ULSA EC 025, 035, 050 & 075 (all dimensions in mm, tolerance ± 3mm)

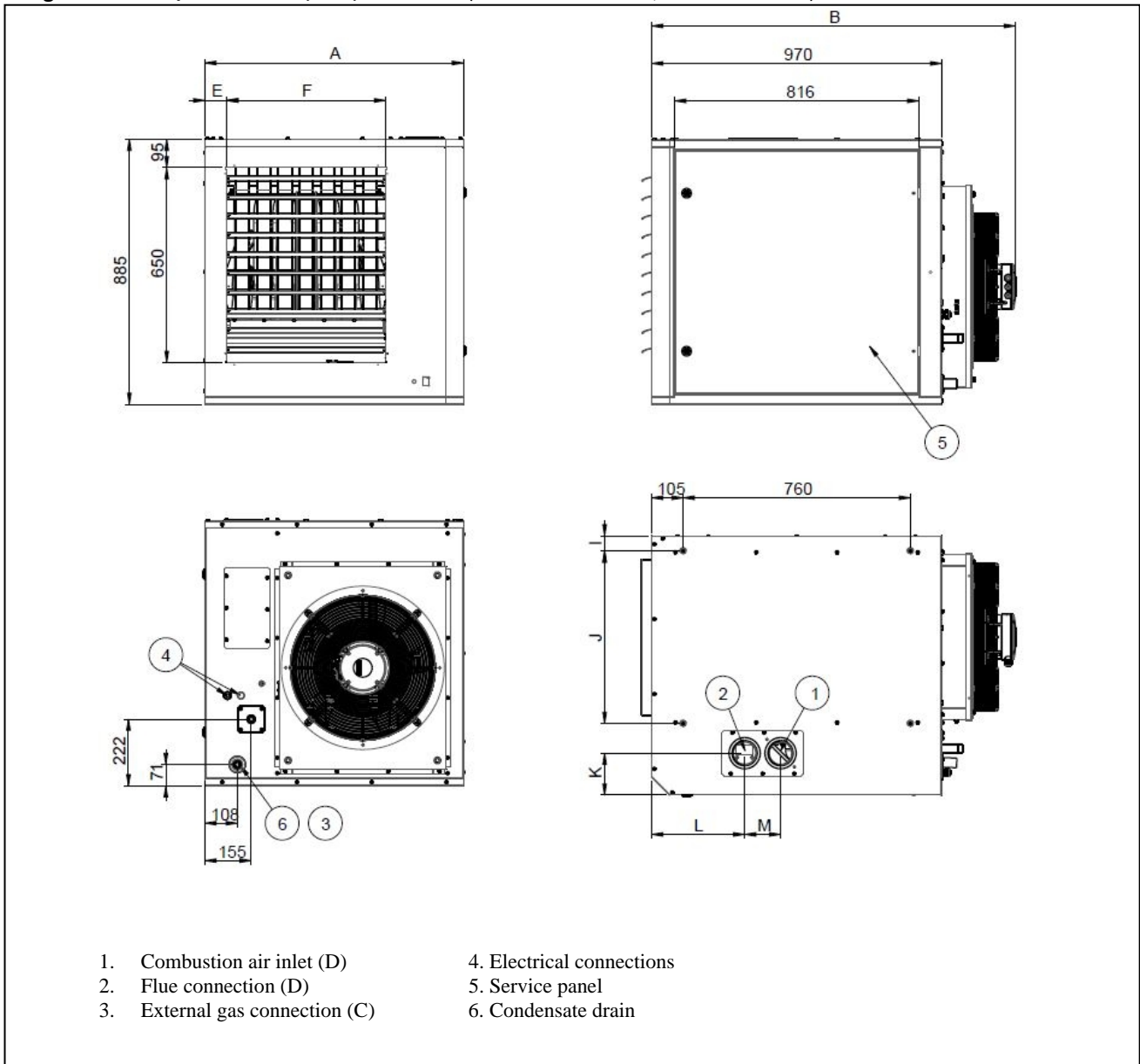

ULSA/ULSA EC	A	B	C	Ø D	E	F	I	J	K	L	M
025	738	1217	1/2" G	80	82	405	55	449	135	311	120
035	738	1217	1/2" G	80	82	405	55	449	135	311	120
050	865	1216	3/4" G	80	74	531	50	576	140	311	120
075	1177	1274	3/4" G	100	129	760	78	860	143	294	140

► **Figure 1b : ULSA/ULSA EC 100** (all dimensions in mm, tolerance ± 3mm)

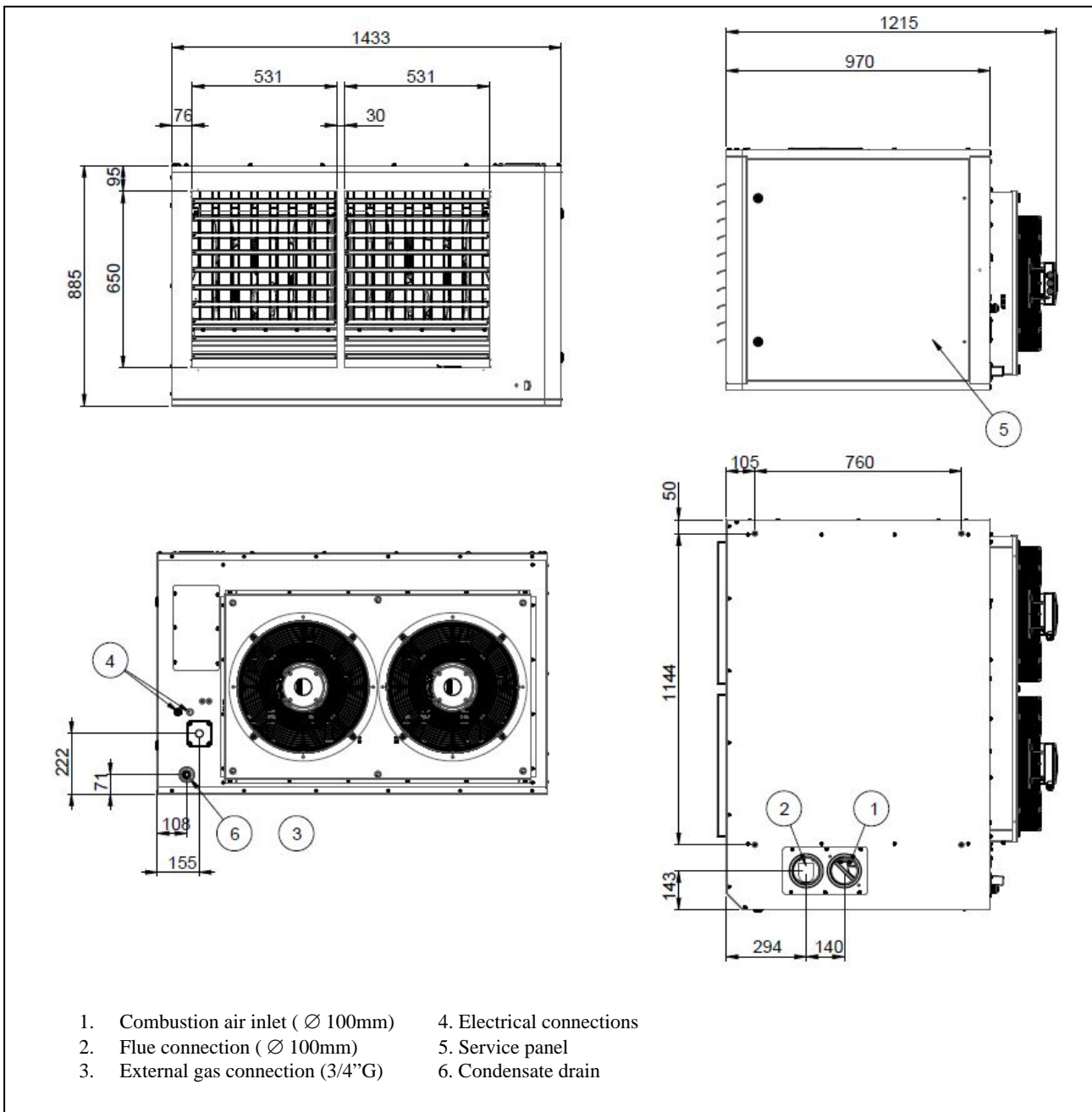

- | | |
|-------------------------------------|---------------------------|
| 1. Combustion air inlet (Ø 100mm) | 4. Electrical connections |
| 2. Flue connection (Ø 100mm) | 5. Service panel |
| 3. External gas connection (3/4" G) | 6. Condensate drain |

4.2 CLEARANCES

Figure 2 :

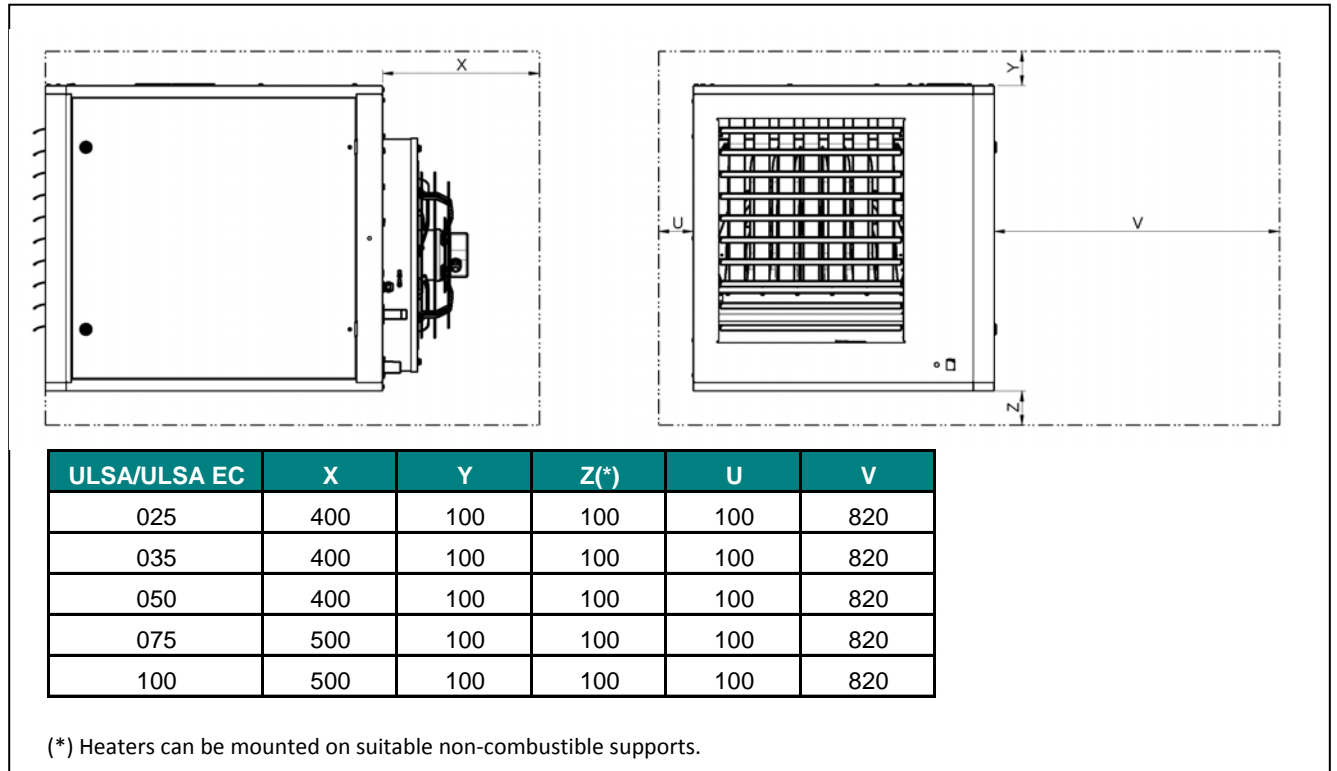

5. INTERNAL LAYOUT

Figure 3 :

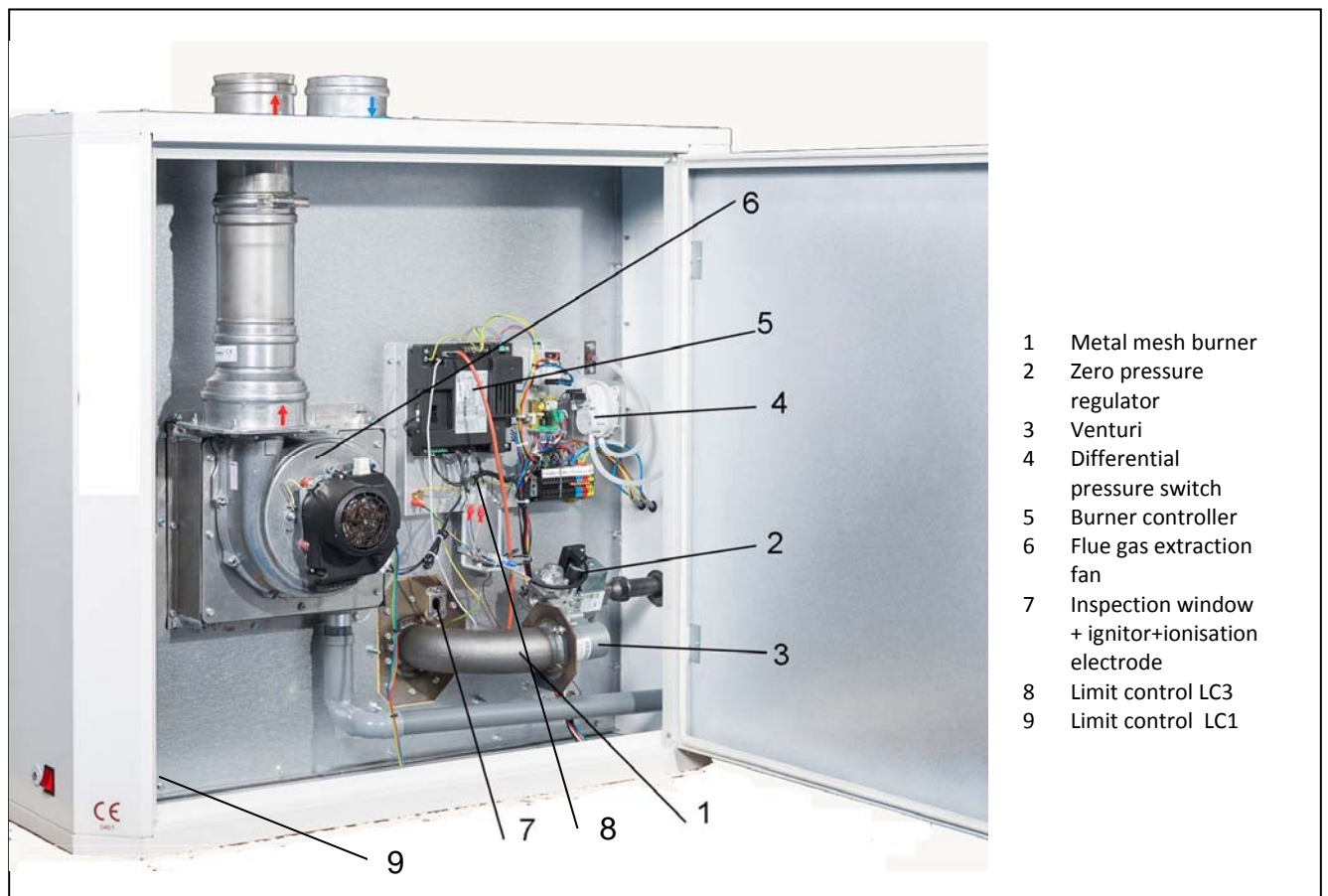

6 INSTALLING



WARNING

- Check the supporting structure to verify that it has sufficient load-carrying capacity to support the unit weight.
- Suspend the heater only from the threaded nut inserts. Do not suspend from the heater cabinet panels.
- Do not place or add additional weight to the suspended heater.

- The location where the air heater is to be installed must provide sufficient space around the heater for servicing and clearances for safety (see figure 2).
- When the unit is lifted for suspension, leave the unit on the pallet. Before hanging verify that all screws originally used to fix the shipping supports are re-screwed into the cabinet.
- Ensure that the heater is installed in a level plane and vibration free.
- The air heater must be fastened securely to any base mounting arrangement.
- The heater is supplied with four point suspension. All points must be used. Threaded nut inserts are provided on each side of the top of the heater. See figure 4.
- After suspension the air heater should be rigid so as to avoid placing a strain on the flue system, gas services, electrical wiring and duct work. 1" BSP mounting cap nuts are optional.
- In case of a type C installation, the distance between the floor and the underside of the air heater must be at least 1.70m. Combustion air should be taken from a height that exceeds the above mentioned height of 1.70m. Also thermostats and switches which are not sparkless have to be installed at a minimum height of 1.70m.

Figure 4

Be sure that the threaded hanger rods are locked to the heater as illustrated in this figure. Recommended maximum hanger rod length is 1.8m. Where longer drops are required, ensure that restraints are fitted to prevent excess lateral movement and supports are adequately sized. Alternatively the unit can also be base mounted on a non-combustible support. In this case ensure that unit is securely fixed on the base.

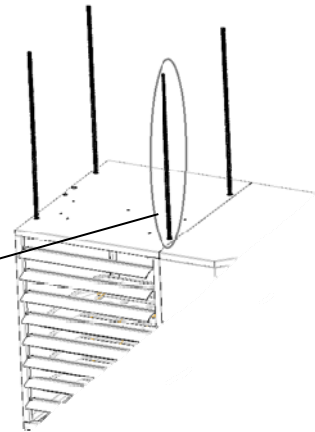
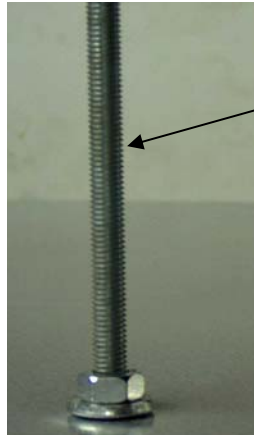

7 AIR SUPPLY & FLUE SYSTEM

7.1 GENERAL



- The flue must be in accordance with all international and national rules and regulations in force. Local requirements may apply in addition to national requirements.
- Failure to provide proper flueing could result in death, serious injury and/or property damage.
- The products of combustion must be flued to outside atmosphere. Common flues (for more than one appliance) must not be used.
- Single wall flue pipe exposed to cold air or run through unheated areas should be insulated to avoid condensation.
- If the flue passes through a combustible element of the building it must be enclosed by a sleeve of non-combustible material and separated from the sleeve by at least a 25mm air break. The temperature of any combustible material near to the flue must not exceed 65°C when the heater is in operation. The flue must be at least 50mm away from any combustible material.
- Provision must be made for condensation to flow freely to a point to which it can be released, i.e. drain.

Model ULSA/ULSA EC heaters may be installed as type B or type C installations. The unit heaters are designed to operate safely and efficiently with either a horizontal or vertical flue system when installed according to the specific requirements and instructions. If this heater is replacing an existing heater, be sure that the flue is of the correct size and that the existing flue is in good condition. A correctly sized flue system is required for safe operation of the heater. An improper sized flue system can cause unsafe conditions and/or create condensation. The units may be installed as a balanced flue type C heater requiring both a combustion air inlet pipe and a flue pipe or as a power vented heater type B where the combustion air is taken from the space where heater is installed and which requires only a flue pipe exhausting to outdoors. All products of combustion must be flued to outdoor atmosphere.

Each heater installed as a type B appliance must be fitted with an individual flue pipe and the combustion air inlet opening must be provided with a protection grill.

Each heater installed as a type C appliance must be fitted with an individual combustion air/flue pipe system. Type C2 appliance, with single pipe system for supply of combustion air and evacuation of flue gasses, are not allowed. For testing, the flue pipe should include a sealable test point. Ideally the test point should be at least 450mm away from the air heater flue connection socket. However if a concentric flue is attached directly to the connection sockets then the combustion should be tested through the flue outlet collar via a drilled test point which must be securely plugged on completion.

Follow the flue pipe manufacturer's installation instructions for making joints, including connections to the air heater, for passing through a building element and for support requirements.

Figure 5 :

Combustion air and flue pipe sockets (standard version)

Remark :

A cover plate can be installed on the rear or top panel. The plate with the fresh air inlet and the flue outlet socket is factory installed on the top panel but can easily be replaced on the rear panel if required. In case of change, a separate kit must be ordered at the supplier.

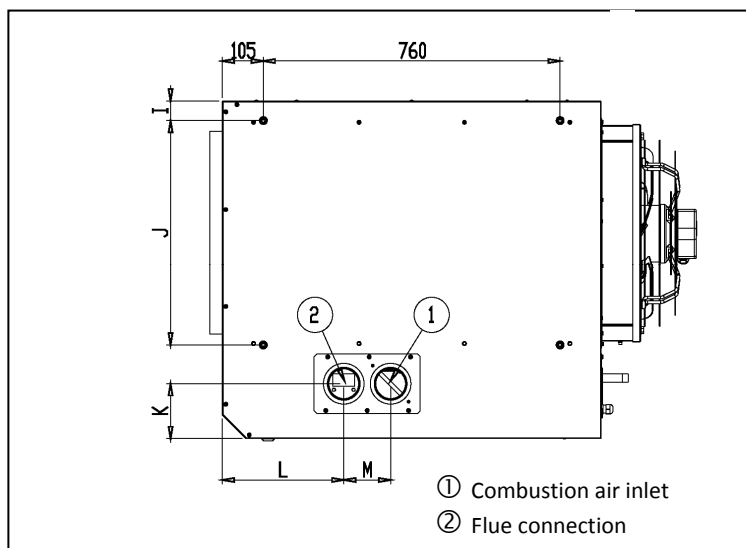

Condense drain

Attention

A condensation drain must be fitted to both the unit and the flue outlet to properly drain all condensation.

The condensation drain from the flue must be constructed from non-corrodible material not less than 20mm diameter. Copper or copper based alloys must not be used for condensation drain. Consult section 8 : Condensation drain pipe connections

7.2 POWER VENTED INSTALLATIONS (type B appliances)

If the air heater is to be installed as a type B appliance, air for combustion will be taken from within the space where the heater is installed.

Ensure that an adequate air supply for combustion and ventilation is provided within the building in accordance with BS6230 or BS5440 plus all other relevant regulations & rules in force.

Single wall flue pipe seamless aluminium/stainless steel pipes are required. All joints must be sealed to prevent products of combustion from leaking into the building.

Do not install vent piping near any source of heat
A protection grill type IP20 must be mounted on the combustion air intake.

Table 2 shows the flue pipe sizes and maximum pipe lengths.

Figure 6 :
Approved appliances type B

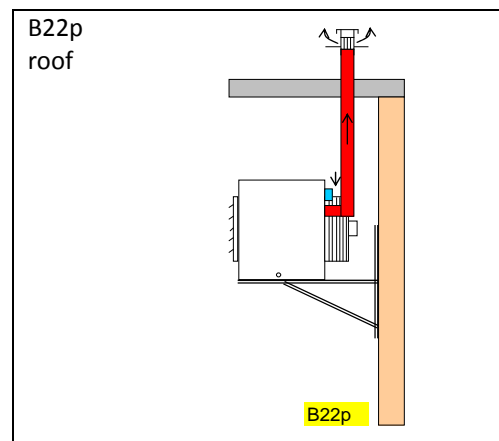

7.3 BALANCED FLUE INSTALLATION (type C appliances)

Balanced flue air heaters are designed to be fitted with a combustion air inlet pipe that obtains outdoor air and a flue pipe that exhausts flue products to outdoors.

Both the flue and combustion air pipes must be sealed. Use gasket sealed seamless aluminium pipe or equivalent. If more than one air heater is being installed in the same place, each heater must have a separate flue system.

Attention

C2 appliances must not be applied !

Figure 7 : Type C appliances : combustion air and flue pipe sockets

- ◆ Vertical flue kit, option 302



- ◆ Horizontal flue kit, option 301



Figure 8 :Approved appliances type C

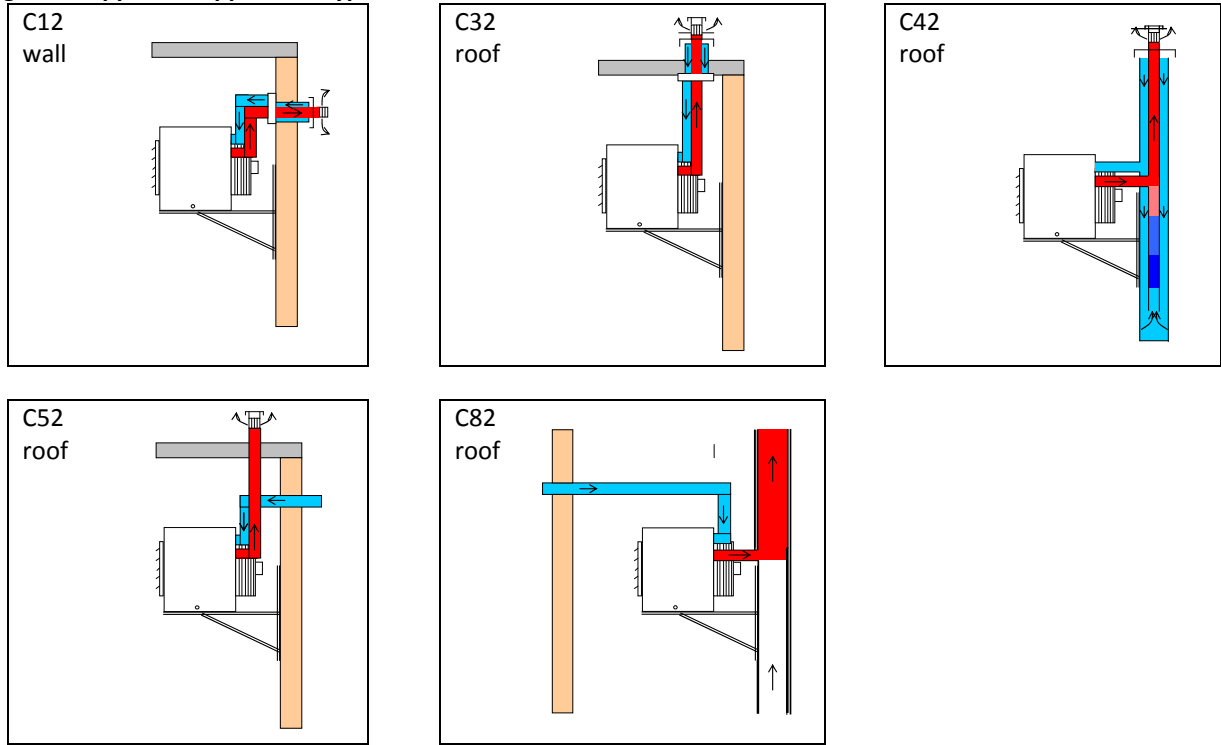

7.4 DIAMETER & MAXIMUM FLUE PIPE LENGTHS

Flue pipe diameters and maximum pipe lengths in table 2 apply to both horizontal and vertical systems. Add all straight sections and equivalent lengths for elbow. The total combined length must not exceed the maximum flue length.

Table 2 :

Model ULSA/ULSA EC			025	035	050	075	100
Heater socket & pipe dia	mm	flue/inlet pipe	80	80	80	100	100
Max. straight length 2 pipes (combustion air inlet pipe & flue outlet pipe)(with wall or roof terminal) (C appliance)	m	flue/inlet pipe	20	20	20	20	20
Max. straight length 1 pipe B23P (flue outlet pipe)(with wall or roof terminal)	m	flue/inlet pipe	30	30	30	30	30
Max. straight concentric length for combustion air inlet pipe & flue outlet pipe (1)	m	flue/inlet pipe	15	15	15	15	15
Equivalent length of 45° concentric elbow	m	flue/inlet pipe	0,85	0,85	0,70	1,10	0,75
Equivalent length of 45° elbow	m	flue/inlet pipe	0,75	0,75	0,75	0,75	0,75
Equivalent length of 90° concentric elbow	m	flue/inlet pipe	1,70	1,70	1,40	2,20	1,50
Equivalent length of 90° elbow	m	flue/inlet pipe	1,50	1,50	1,50	1,50	1,50

(1) : ULSA(EC) 025,035, 050 : dia 80/125mm / ULSA(EC) 075,100 : dia 100/150mm

-use same diameter for all flue pipes

-recommended minimum flue = 1m

IMPORTANT: Only use Muelink & Grof type Skyline 3000 for wall or roof terminal or equivalent type

7.5 AIR SUPPLY



WARNING When these air heaters are installed as type B appliances, they take their air for combustion from the space in which they are installed. Do not restrict the combustion air intake.

It is important to ensure that there is an adequate air supply at all times for both combustion and heating requirements. Modern buildings involve greater use of insulation, improved vapour barriers and weather proofing. These practices mean that buildings are sealed much tighter than in the past.

Proper combustion air supply for a power vented type B installation requires ventilation of the heated space. Natural infiltration of air may not be adequate. Use of exhaust fans aggravates this situation. It is important to ensure that there is adequate combustion air supply at all times. Reliance on doors and windows is not permitted. Always ensure that an adequate inlet for fresh air for combustion is provided sized to suit the total installation of any combustion apparatus.

8 CONDENSATION DRAIN PIPE CONNECTIONS

- All ULSA/ULSA EC units are designed with a built-in siphon (PN 70 61761) (figure 9). Attention : in case replacement of siphon is necessary, ensure that siphon is correctly installed. (see figure 10).

Figure 9



Figure 10



- It is recommended to use a PVC discharge pipe.
- The condensation connection between the air heater and the siphon has a 32 mm diameter and must be glued (leak proof) onto the siphon inlet.
- To ensure the condensation water does not freeze, it is recommended to mount the drain pipe inside the building. If there is no other choice but mounting it outside, it is strongly recommended to equip it with frost proof insulation.
- When connecting the siphon, it is necessary to use sealing rings (in the siphon outlet). Ensure these sealing rings are correctly mounted.
- Condensation drain pipe connections must be glued, to prevent condensation water dripping from the drain pipe.
- If you want to open the siphon (e.g. to clean it), the air heater must be shut down.
- For security reasons it is recommended to wear gloves when cleaning the siphon.
- The siphon has to be cleaned yearly and also checked for metal sludge. In the event that there is a lot of metal sludge present, the air heater must be serviced more frequently.
- The condensation water coming from the air heater has a pH-level of approx 4.6 and can affect materials made from zinc and/or copper.
- Hence, it is strongly advised against letting the condensation water flow off through the gutter.
- Condensation water does not belong in a rain-water tank !
- Downstream from the traps the condensate drains may be joined and both must be connected to a sanitary drain within the building. Check codes to be certain that this is permitted (condensate from the heater has about the acidity of soda pop and is not harmful to a sanitary drain). ULSA/ULSA EC heaters will produce condensate depending on size and gas type (see table 3).
- A condensate disposal system that relies on gravity should be satisfactory for most installations since unit heaters are normally installed several metres above the floor.
- If a gravity system is not possible, a condensate pump must be installed. There are a number of commercially available pumps made for this purpose. If using a condensate pump, follow the pump manufacturer's installation recommendations.

Table 3 :
Condense drain rates of flow

ULSA/ULSA EC		025	035	050	075	100
Natural gas/ Propane	l/h	1,2	1,3	1,8	2,1	3,7

9 GAS SUPPLY & GAS CONNECTION

☛ We refer to table 1 of section 3 for all gas specifications



- Connection to a gas service installation may only be carried out by suitably qualified persons.
- The gas installation must comply with all rules in force.
- Only materials appropriate for gas service installation may be used.
- Do not rely on the heater to support the gas pipe.
- **NEVER USE A FLAME TO TEST FOR GAS SOUNDNESS. ALL COMPONENTS OF A GAS SUPPLY SYSTEM MUST BE LEAK TESTED PRIOR TO PLACING EQUIPMENT IN SERVICE. FAILURE TO COMPLY COULD RESULT IN PERSONAL INJURY, PROPERTY DAMAGE OR DEATH!**

9.1 GENERAL

ULSA/ULSA EC heaters are designed to operate on either natural gas (G20), propane (G31) or butane (G30) gas. Check that gas supply, gas category & gas inlet pressure is in accordance with the data described on the air heater. To let the unit function at maximal heat output, the gas supply pipe **MUST** be correctly sized. Close to the air heater a gas tap with coupling must be mounted for servicing (see figure 11). It is strongly recommended to place a gas filter and clean the gas tube with nitrogen.

The whole of the gas service installation including the meter must be inspected, tested for soundness and purged in accordance with appropriate requirements by a qualified person.

Figure 11

9.2 GAS CONNECTION

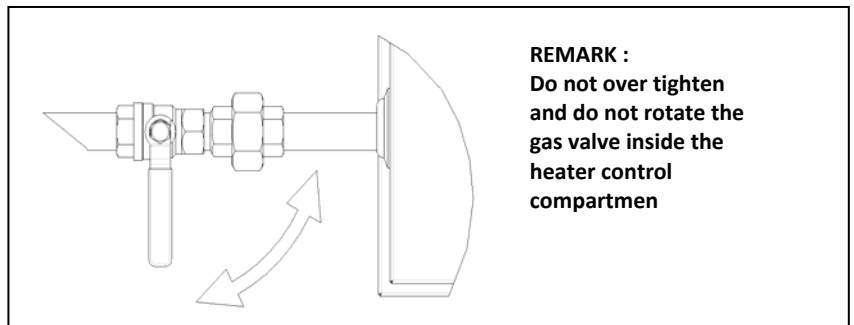
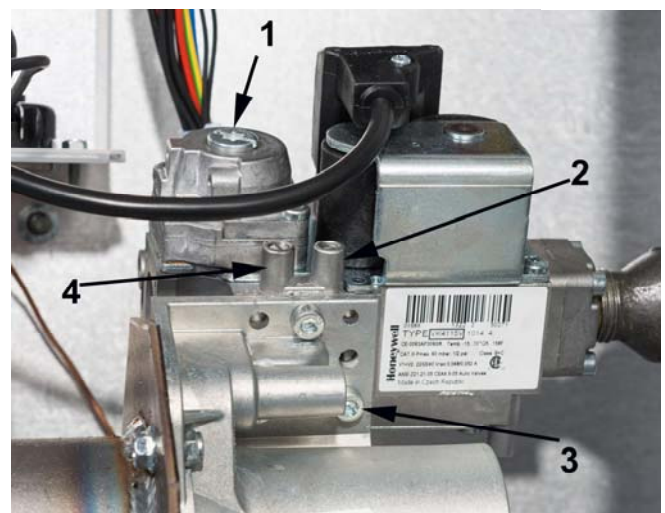

Figure 12

9.3 ADJUSTMENT GAS VALVE

- To adjust the offset, remove the protection screw on the top and regulate the offset by using the exposed screw. Offset values will be measured in the indicated points.
- To adjust the CO₂, use a screwdriver in the indicated spot and turn the screw driver clockwise to decrease the measured CO₂ or turn it counter clockwise to increase the measured CO₂. The CO₂ measurement should be done in the flue discharge pipe.

☛ **All units are set according to the data plate before leaving the factory. Any modification to the gas valve must be done by a qualified technician.**



- | | |
|---|---|
| 1 | Offset adjustment point |
| 2 | Inlet pressure measuring point |
| 3 | CO ₂ adjustment point (throttle) |
| 4 | Offset measuring point |

9.4 GAS CONVERSION

The ULSA/ULSA EC heaters are designed to operate on natural, propane or butane gas and will be supplied for the gas type ordered. In the event a site conversion is required, it is necessary to change the burner jet and gas valve. Affix new data plate and gas type label.

Upon completion of conversion recommission the heater. We hereto refer to the section 'Ignition system'

Changes to carry out :

1 From natural gas to propane :

A propane conversion kit [part number 03 49950 -----] will have to be purchased in order to perform the conversion. The conversion kit consists of the propane restrictor and the connector (see item 3 for more details) that will provide the necessary speed for the exhaust blower. In order for the unit to be set for propane, the gas valve will be removed from the venturi by removing the three fixing screws. The brass restrictor will be placed inside the O-ring as depicted in figure 13 and the gas valve will be repositioned on the venturi.

Throttle adjustments and CO₂ measurements will have to be made in order to obtain the recommended CO₂ value. For details please see the CO₂/Throttle adjustment section 9.3.

☛ **Attention** : Always consult the appropriate instruction with reference xxx0311₁/xxx0311₂-EN providing all needed data and information to perform the conversion..

Figure 13

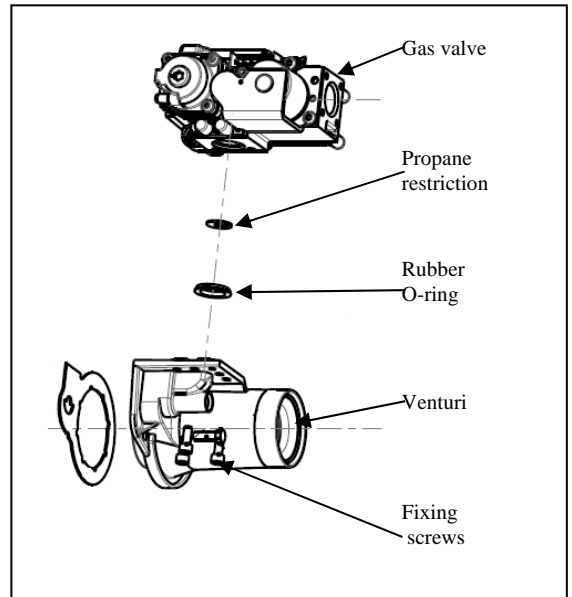

2 From propane to natural gas

In order for a heater set on propane to be converted to natural gas, the brass restrictor will be removed and throttle adjustments* and CO₂ adjustments (*) remade in order to achieve the normal values for natural gas.

Figure 14 : Natural gas



Figure 15 : Propane

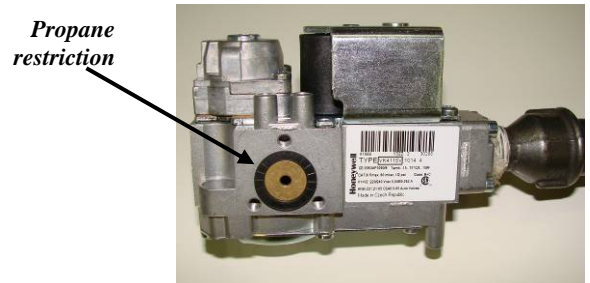

(*) If an error is made, and the unit has only the brass propane restrictor removed without having the combustion values checked, permanent damage to the unit will occur.

3. Connector

Inscription on the connector indicates the size of the unit and the type of gas to be used.

Example: in photo 16 the unit is a ULSA/ULSA EC 50 set for natural gas.

The connector for propane use is provided with a red wire mentioning the inscription PROP (see photo 17).

Figur 16



Figur 17



10 ELECTRICAL SUPPLY & CONNECTIONS

10.1 ELECTRICAL SUPPLY



DANGER

- **THIS APPLIANCE MUST BE EARTHED.**
- **The electrical installation may only be carried out by suitably qualified persons observing the rules in force.**

Check that the electrical specifications are in accordance with the data on the air heater. All electrical connections should be in accordance with the terminal markings and the wiring diagram affixed to the air heater.

The minimum external controls required for the air heater are a room thermostat. It is essential that the main input line and neutral to terminals L and N remains live at all times even when the appliance is switched off, this is to ensure correct operation of the unit.

The minimum clearance distance between the contacts must be more than 3mm. Check that the air heater is well earthed and that an earth leakage test is carried out. The electrical supply line to the heater should include a main isolating switch.

An external orange indicator light is fitted on the heater to signify when the burner is ON.

An external burner reset switch with red indicator light is fitted on the heater. To add a remote reset button, make connections to the terminals in the electric box as indicated on the wiring diagram.

Ensure that all cables and installers wiring are appropriately fixed and that they do not touch the flue combustion collector box.

To ensure that the unit is airtight, all unused cable couplings must be hermetically sealed.

Attention

- Permanent damage can occur to the burner relay when faulty/incorrect connections to the thermostat, reset switch or burner failure lamp are made!
- Switching of wires for reset switch and flame failure will destroy the burner relay.
- If the reset button requires activating for any reason, the cause must be determined. After determining and correcting the problem, restart the heater and monitor long enough to ensure proper operation (approx. 5 minutes).

10.2 THERMOSTAT LOCATION

General

Do not attempt to control more than 1 heater from a single thermostat or control panel unless a properly wired relay is fitted. Follow the instructions supplied with such panels.

The location of the room thermostat or sensor is very important. It should not be positioned on a cold wall or cold surface. Avoid location in draughty areas or where it may be influenced by heat sources e.g. the sun, process plant, etc...

The thermostat should be mounted on a vibration free surface and mounted about 1.5m above floor level. Follow the thermostat manufacturer's instructions.

Possible control systems

1. **By means of option 954** = Individual on/off control (0% or 100% functioning)
2. **By means of option 952** = weekly programming digital chronothermostat (GA11) used for remote control of several units (consult option 952 instruction for more details)

Example

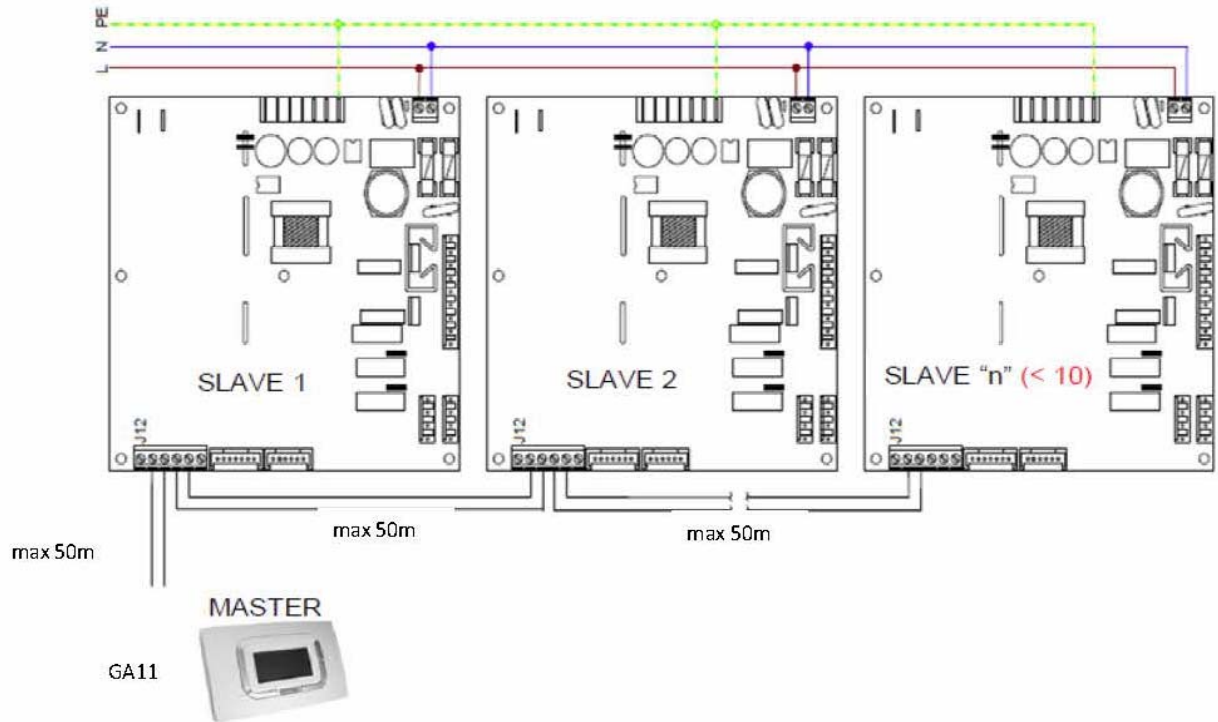

3. **By means of 0-10V power signal** (to be performed by customer)

Example

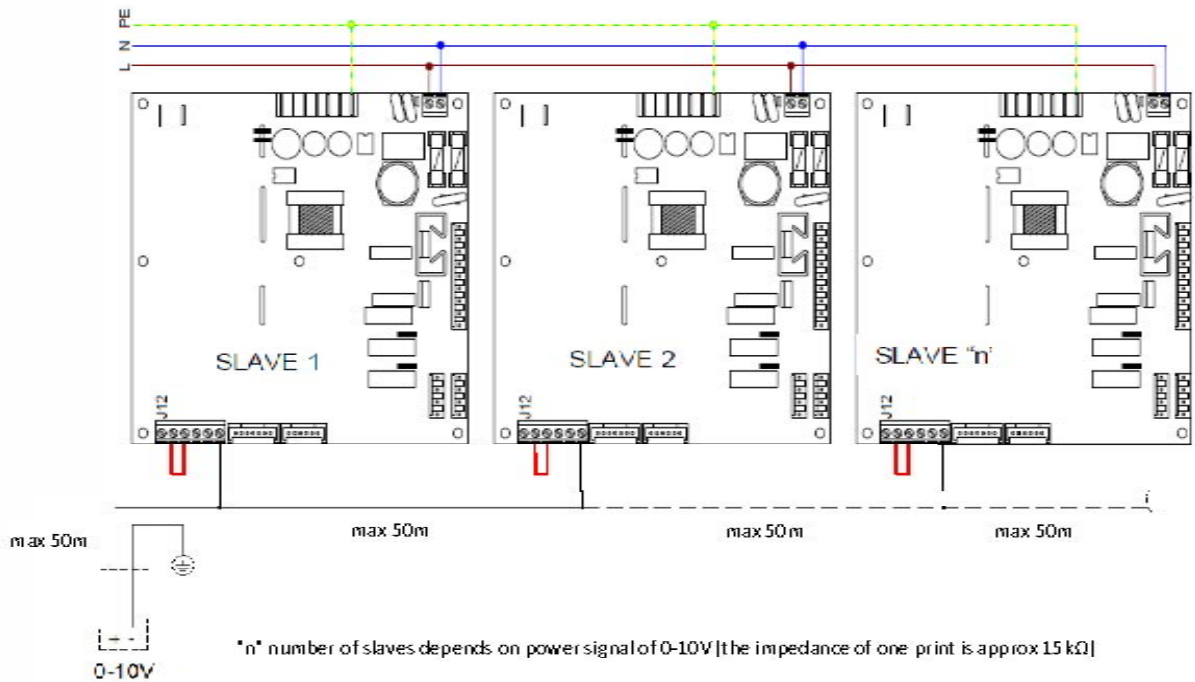

11. COMMISSIONING, LIGHTING & OPERATION

Final testing after production ensures that, if the installation has been carried out strictly in accordance with this document, the appliance is ready to be taken into service.

11.1 LIGHTING

1. Ensure that the air discharge louvres are open.
2. Turn on the gas supply.
3. Switch on the electrical supply.
4. Set the room thermostat to 'ON' position.
5. If the indicator light on the burner relay glows and/or the room thermostat display flashes, press the reset button.
6. The burner will now automatically light after about 15 sec and within 60 sec the air circulation fan will run.
7. If the installation is new, 3 start-up cycles may be necessary due to air still being present in the gas pipe. Should the air heater still not light, refer to section 12 : 'Fault Finding'.
8. The gas pressure must correspond to the data in table 1. If the gas pressure (G20) is higher than 60mbar, a pressure regulator with constant terminal pressure must be installed. If the gas pressure is lower than 20mbar/17.50mbar, check the supply pipework to ensure it is correctly sized.









11.2 OPERATION

Attention

During start up all gas services (up to the gas meter) must be checked again for gas soundness to ensure no leaks are present.
The condensation drain pipe and siphon, both already filled with water, must be visually tested for water tightness.

1. If, for any reason, the burner flame is extinguished during a run cycle, an automatic attempt for re-ignition will take place. If the burner does not relight, safety shut down and lockout will occur. Manual intervention to reset will be necessary to put the air heater back into service.
2. In the event of overheating for any reason, overheat controls operate to switch off the burner. In case the heat exchanger's temperature is too high, the burner will be switched off by the LC1 limit control (first safety). The burner automatically switches on again after cooling down and re-start will take place. The limit control LC3, which operates at a higher temperature setting, switches off the burner and itself to a lockout condition requiring a thorough check of the heater and a manual reset via the burner relay or the remote control to restore the heater to operational condition. A cooling time of about 1 minute is necessary before resetting.
3. When the set temperature has been reached, the comfort regulation ensures modulation on the burner. To compensate possible heat losses, warmth is still dissipated by the air heater itself.
4. To turn off the air heater for a short period, turn the room thermostat to a lower setting. To relight, reset the thermostat.
5. To turn off the heater for a prolonged period, turn the room thermostat to lowest setting and turn off the gas supply to the appliance. Switch off electrical supply to the air heater **only after the air circulation fan has stopped**. To relight, follow the lighting instructions.
6. Gas and electricity must only be turned off in case of emergency or for prolonged periods of shutdown of the air heater.

11.3 LED STATUS

	LC1 open or short-circuit / no resistance at print / abnormal ignition (turn power on/off)
	Prepurge time
	Ignition
	Stabilisation
	Unit is functioning
	General failure
	Failure LC3
	LC1 open or short-circuit / no resistance at print / abnormal ignition (turn power on/off)
	S3 open (must be closed when main fan is working)

Ignition system – time table

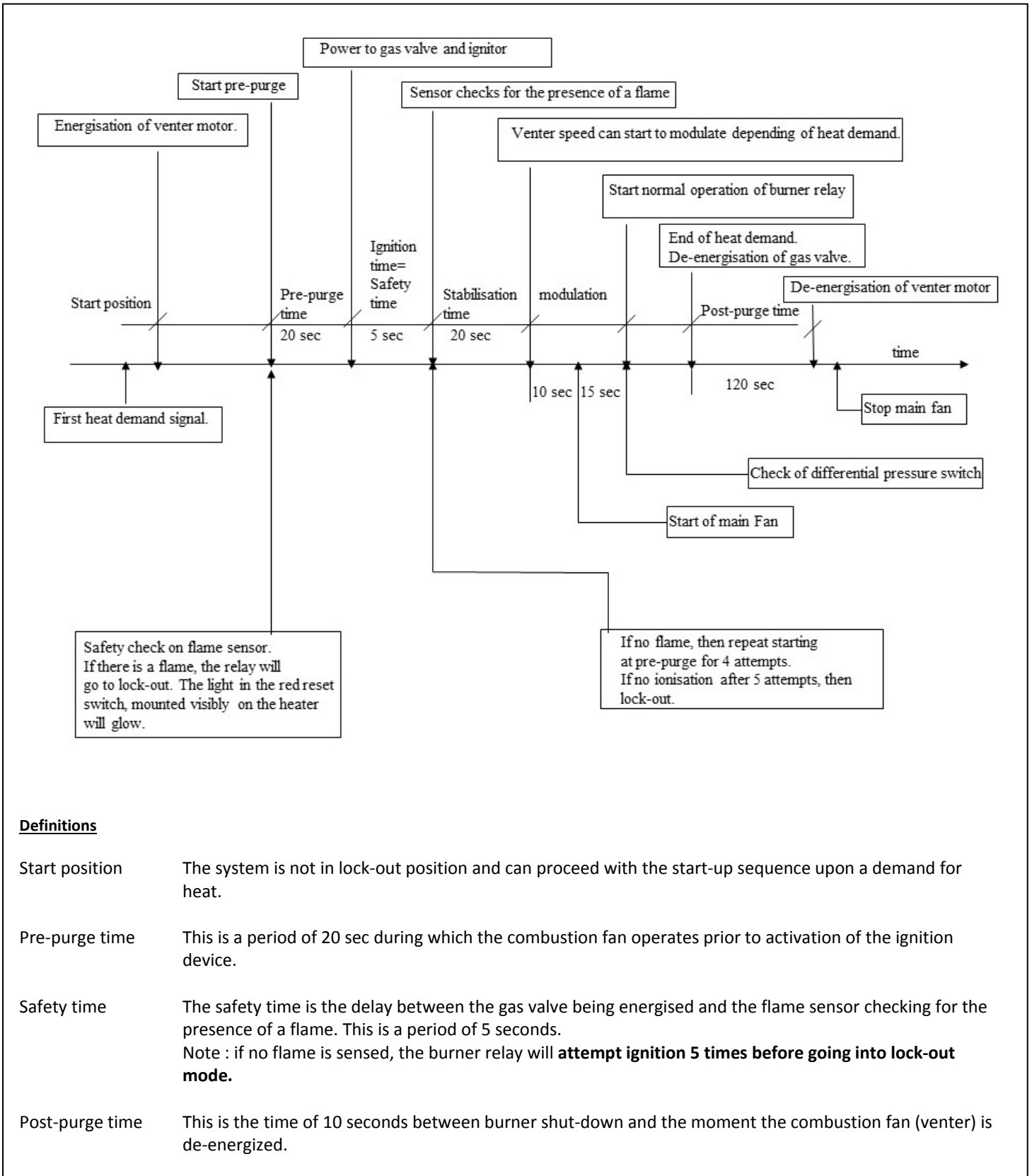

Definitions

- | | |
|-----------------|--|
| Start position | The system is not in lock-out position and can proceed with the start-up sequence upon a demand for heat. |
| Pre-purge time | This is a period of 20 sec during which the combustion fan operates prior to activation of the ignition device. |
| Safety time | The safety time is the delay between the gas valve being energised and the flame sensor checking for the presence of a flame. This is a period of 5 seconds.
Note : if no flame is sensed, the burner relay will attempt ignition 5 times before going into lock-out mode. |
| Post-purge time | This is the time of 10 seconds between burner shut-down and the moment the combustion fan (venter) is de-energized. |

12. MAINTENANCE

Attention

It is recommended that maintenance is carried out at least once a year. More frequent servicing may be required dependent upon the environmental circumstances where the air heater is installed. Regular inspection is necessary, especially in dirty areas, to assess the servicing frequency.

Removal of service panel

1. Remove door lock at upper and underside.
2. Lift the panel holding it at the bottom.

Substitution of combustion air fan

1. Turn off the main gas supply.
2. Set the room thermostat so there is no heat demand.
3. Wait until the air circulation fan has stopped running.
4. Check that the electrical supply is turned off.
5. Remove the service panel (see 'removal of service panel').
6. Disconnect the plugs from the combustion air fan.
7. Remove the bolts between the combustion air fan and the (bent) gas supply tube. Remove the gasket.
8. Remove the fixing screws (or the assembly in case of a ULSA 075/100 EC) connecting the air intake restriction and the combustion air fan.
9. The combustion air fan can now be removed.
10. Remove all the dust from the combustion air fan with a soft cloth or brush.
11. Check that the motor and the turbine are undamaged.
12. Replace all parts in reverse order.

Substitution of bulb thermostat LC3

1. Wait until the air circulation fan has stopped running.
2. Before starting, ensure that the electrical supply is turned off and locked.
3. Remove the service panel (see 'removal of service panel').
4. Remove the bracket by using the LC3.
5. Disconnect the electrical connections on the bulb thermostat.
6. Remove the fixing screws connecting the bulb thermostat to the electrical wiring panel.
7. The whole bulb thermostat is now loose and can be removed.
8. Replace all parts in reverse order.

Substitution of bulb thermostat LC1

1. Remove the thermocouple via the air outlet side of the air heater.
2. Follow the above instructions No 6 to 8 for the bulb thermostat LC3.

Cleaning & substitution of burner

When cleaning and re-installing the burner, it is necessary to make use of a kit specially designed for ULSA/ULSA EC units. Use only kits which are approved by the manufacturer and which are appropriate for your appliance.

Use kit number 36 25192 025 for unit ULSA (EC) type 025 – For all other types, use kit number 36 25192 035.

Always consult your distributor at the slightest doubt.

Substitution of gas valve

(differs according to the application and has to be ordered at your distributor)

1. Check that the air circulation fan has stopped running.
2. Before starting ensure that the electrical supply is turned off and locked.
3. Check that the gas supply is turned off.
4. Remove the service panel (see 'removal of the service panel').
5. Disconnect the burner relay from the gas valve unscrewing the fixing screw.
6. Take a short screw driver and remove the screws connecting the gas valve and the air intake restriction.
7. Disconnect the gas valve from the gas connection.
8. Replace the gas valve in reverse order.

Substitution of one of the relays

1. Check that the air circulation fan has stopped running.
2. Before starting, ensure that the electricity supply is turned off and locked.
3. Remove the service panel (see 'removal of the service panel').
4. Disconnect all the relay connections.
5. Remove the fixing screws of the contactor.
6. Replace the relay in reverse order.

Substitution of air circulation fan (entirety)

1. Check that the air circulation fan has stopped running.
2. Before starting, ensure that the electricity supply is turned off and locked.
3. Remove the service panel (see 'removal of the service panel').
4. Disconnect the electrical connections of the air circulation fan. These connections are on the electrical connections terminal (see the wiring diagram).
5. Loosen the cable gland.
6. Pull the cable through the cable gland towards the motor.
7. The air circulation fan can now be removed. Note: for safety reasons it is strongly recommended to wear gloves when substituting the air circulation fan.
8. Replace the air circulation fan in reverse order.

Substitution of the programmable room thermostat

1. Check that the air circulation fan has stopped running.
2. Before starting, ensure that the electricity supply is turned off and locked.
3. Loosen the thermostat by pressing the spring mounted part of the fixing with a screwdriver and tipping it carefully upwards. By doing this the thermostat will loosen from the panel.
4. When substituting, protect the contacts in the wall plate against paint and other substances that can disturb the functioning.
5. At the bottom there is a plastic screw. Turn this screw a quarter of a turn so that the valve inside the thermostat can open.
6. Once this valve is open, the two wires to the air heater can be disconnected.
7. Close the valve again and put the plastic screw back in original position so that the valve is closed again.
8. Remove the fixing points between the wall plate and the wall.
9. Replace the room thermostat in reversed order.

13. FAULT FINDING

☛ **Fault finding may only be carried out by appropriately qualified persons!**

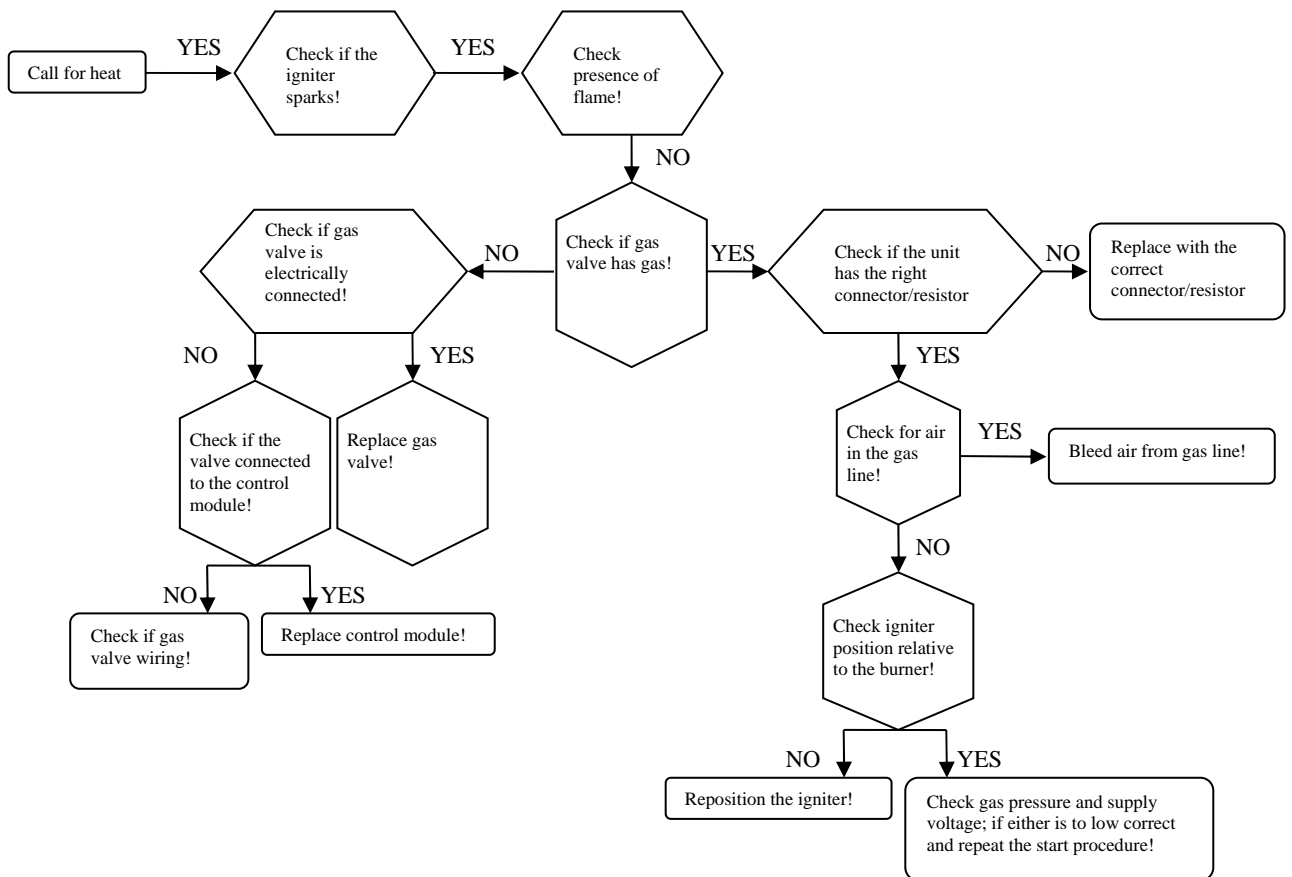
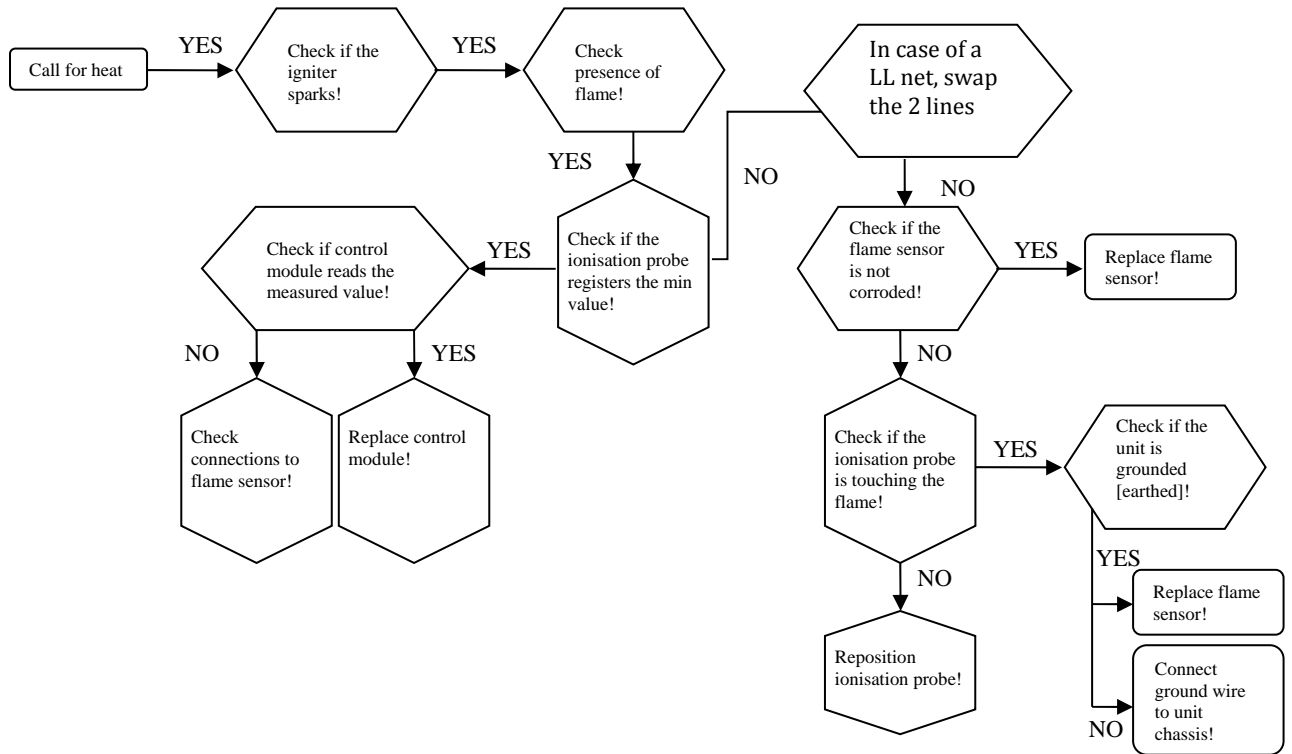

In case of 3*220V it is possible that phase shift results into bad ionisation

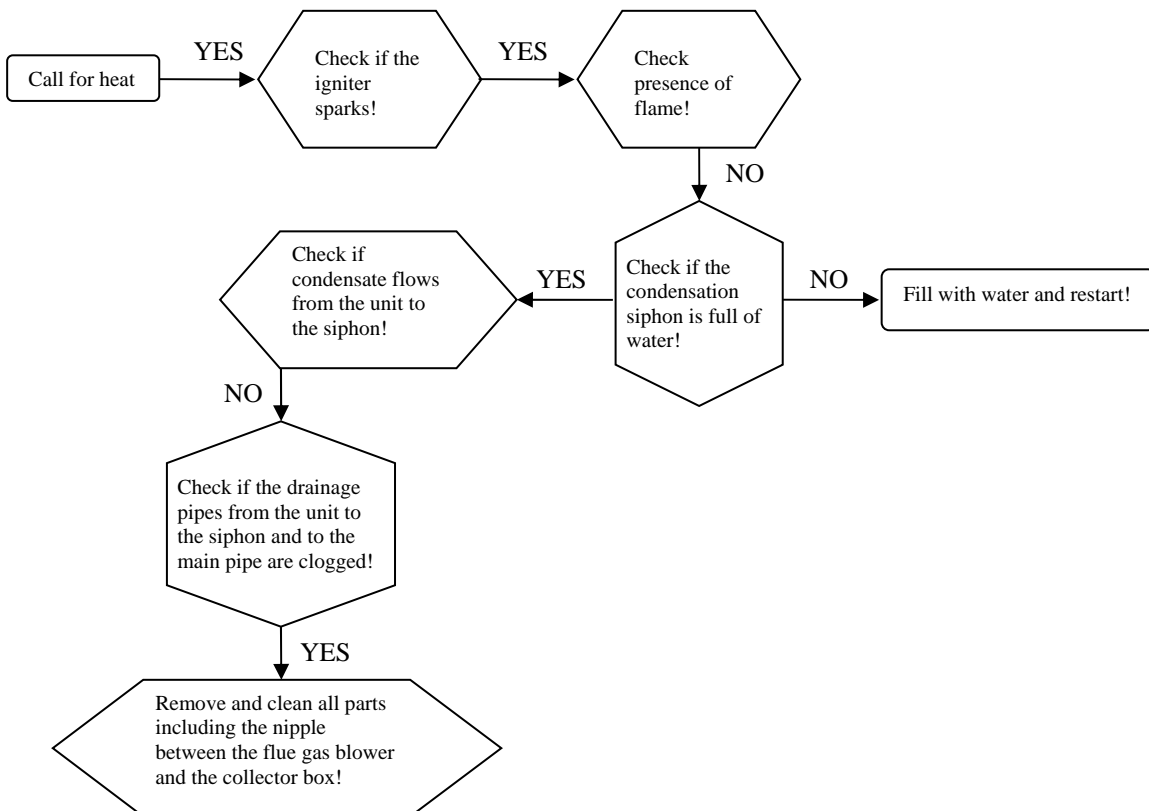
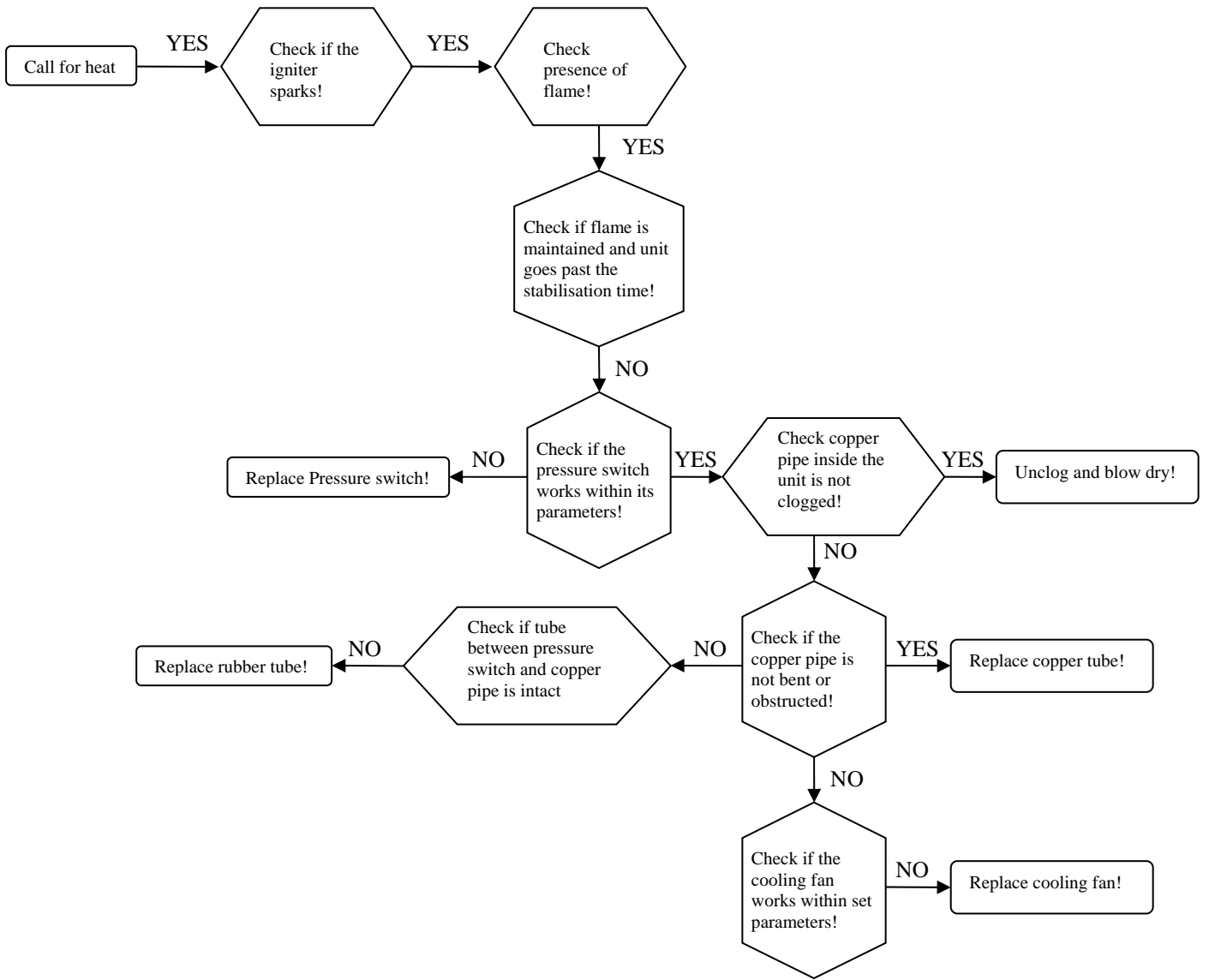

14. PARTS LIST

Description	Part number	Reference	Application
motor+ventilator	01 26060	FN040-4EW.0F.A7P1	025 ULSA AC
motor+ventilator	01 26061	FN040-4EW.0F.A7P2	035 ULSA AC
motor+ventilator	01 26040	FN045-4EW.4I.A7P1	050 ULSA AC
motor+ventilator	01 26063	FN063-6EW.4I.A7P1	075 ULSA AC
motor+ventilator	01 26040 (2x)	FN045-4EW.4I.A7P1	100 ULSA AC
motor+ventilator	01 26070	S3G400-LK08-H4	025 ULSA EC
motor+ventilator	01 26070	S3G400-LK08-H4	035 ULSA EC
motor+ventilator	01 26071	S3G450-LL03-H4	050 ULSA EC
motor+ventilator	01 26072	S3G630-AE55-22	075 ULSA EC
motor+ventilator	01 26071 (2 x)	S3G450-LL03-H4	100 ULSA EC
venter	20 25747	RG148	025-035-050
venter	20 25748	RG175	075-100
burner relay	03 25327	TC340	all
interface burner relay	03 25327 01	344	all
main cable tree	06 41850		all
limit control LC1	05 25167 5050	T7335B	all
limit control LC3	03 24959	542332	all except 075 ULSA EC
limit control LC3	03 24959 03	10H14	075 ULSA EC
flame sensor	05 25171	EXP0048	025
flame sensor	05 25191	PSE-RZ30	035-100
ignition electrode	05 25169	exp0049	025
ignition electrode	05 25190	PSE-RZ29	035-100
reset switch	60 61988	2645	all
signal lamp	60 61997		all
pressostat	30 60621 13	605	all
venturi gas valve	03 25700 003	0 0 3	025
venturi gas valve+40cm tube	03 25700 051	0 51	035
venturi gas valve+20cm tube	03 25700 051	0 51	050
venturi gas valve	03 25700 051	0 51	075
venturi gas valve	03 25700 050	0 50	100
premix gas valve	03 25800	VK4115V	025-075
premix gas valve	03 25801	VK4115VB1012B	100
gas valve plug+wire	03 25141 V1	45900441	all
burner	50 60250 025	51416	025
burner	50 60250 035	51425	035
burner	50 60250 050	51418	050
burner	50 60250 075	51420	075
burner	50 60250 100	51422	100
Coil	30 61742 240V	66.82.8.230.0000	all
Siphon	70 61761	Waven	all

15. USER INSTRUCTIONS

Attention Never switch off electricity supply to the air heater without first closing the gas isolating tap.

How the air heater works:

Gas is burned by an atmospheric burner which fires into a heat exchanger. The gas burner is controlled by a double gas valve via an electronic burner control, which is operated automatically via external controls i.e. a room thermostat and/or a time switch. The burner is lit by a spark igniter. When the burner fires and warms the heat exchanger, the heat is sensed by a thermally operated fan control, which switches on the fan when the air temperature has reached its preset operating level.

At the end of a heating cycle the burner is switched off, the air circulation fan will continue to run until the air heater has cooled to a safe level. Thereafter the fan will remain off until the next cycle is initiated.

Safety:

1. Flame failure is detected by the ionisation probe which is the sensor and will immediately result in gas valve shut down.
2. Safety against overheating is assured by two overheat controls. The first is an automatic resetting control which protects against low air flow i.e. clogged air ways, fan failure etc. The second, which is set to a higher level than the first, is a control which locks out and switches off the burner in the event of gross overheating for any reason. Manual intervention is necessary to reset this control device. Resetting of the automatic burner control may also be required.
3. The location of the air heater should be maintained at normal atmospheric pressure. Changes to the building after air heater installation, should have regard to the heating installation, i.e. structural changes causing excessive draughts from doors, windows etc. Other air handlers and installation of air extraction equipment which may cause a negative pressure environment, can seriously affect the operation of this type of air heater, especially if combustion air supply is taken from within the building.

To light the heater:

1. Turn on the gas supply to the air heater.
2. Switch on the electricity supply to the air heater.
3. Ensure time switch (if fitted) is set to an 'ON' cycle.
4. Adjust control/room thermostat to desired temperature.
5. Air heater will light automatically when the room thermostat calls for heat after about 30 sec.
6. If the appliance does not light:
 - a) check that the burner control does not require resetting. An indicator light glows in the appliance and on a remote control if fitted. Reset by pushing reset/button inside the appliance or the remote control.
 - b) check if thermal overheat control requires resetting
7. If the thermal overheat control requires resetting and doing so restarts the air heater, wait until the appliance warms to thermal equilibrium, to ensure the overheat control does not lock out again. If it does and the temperature near the heater is less than 30°C, then switch off the appliance and call for service. If the temperature is over 30°C, take appropriate action to reduce the ambient temperature near the air heater.

Air circulation:

1. The space heating process is for air to be circulated through the appliance whereby it gains heat from a heat exchanger. The air is directly discharged into the space to be heated. The air is eventually recirculated. Therefore it is very important that an unobstructed path for the circulation of the air will be maintained. This is particularly important if the air heater has been installed to blow through the wall between two rooms.
2. Sometimes the air circulation fan of the appliance is connected to a remote over-ride switch. This enables air to be used for circulation purposes when the air heater is not used for heating purposes e.g. in summer.

To use this feature:

 - a) switch ON electricity
 - b) switch ON manual override switch, this may be fitted as a feature on a remote composite control.
 - c) Correct adjustment of GA&& (see separate option instruction 952)

Maintenance:

1. Maintenance and service must only be carried out by appropriately qualified persons e.g. "Gas safe" registered person.
2. It is in your interest to ensure proper service and maintenance is carried out at a regular basis. Periods between services are dependent upon the local environment where the heater is installed. All gas appliances should be serviced at least once a year.
3. In case of any damage to the appliance, it must be shutdown completely and checked by an appropriately qualified person.
4. In the event of difficulties in resolving any of these matters, please do not hesitate to contact Reznor or their official distributor.

16. DECLARATION OF CONFORMITY

REZNOR®

EC Declaration of Conformity according to
EC Machinery Directive (2006/42/EC)

Nortek Global HVAC Belgium nv
J&M Sabbestraat 130/A000
8930 Menen, Belgium

hereby declare that the gas-fired air heaters

ULSA
025 (EC), 035 (EC), 050 (EC), 075 (EC), 100 (EC)

are in accordance with :

The EEC directive 2014/35/EU : low voltage directive
The EEC directive 2014/30/EU : EMC directive
The EEC directive 2009/142/EC : gas appliance directive
The EEC directive 2006/42/EC : machinery directive

Notified body : Technigas, Rodestraat 125, B 1630 Linkebeek

Notified body number : 0461

Applied harmonized standards :

EN 1020
EN 437
IEC 60259
EN 50165
EN 60335-1
EN 55014-1, EN 55014-2
EN 61000-3-2 & EN 61000-3-3

Menen, 01.022017



Johan Dubus
Engineering Team Leader

 **NORTEK™**
GLOBAL HVAC



NORTEK GLOBAL HVAC Belgium nv

J&M Sabbestraat 130/A000

B 8930 Menen, Belgium

Tel. **+32(0)56 52 95 11**

www.reznor.eu