



NOTICE:



The information contained on the following page(s) was produced prior to May 1, 2014. On that date Reznor became part of Nortek, Inc.

References to any other company affiliations are no longer valid.

IMPORTANT

1. Always include complete heater model and serial number so that any specification change can be considered for parts shipment. It can save time and expense.
2. Specifications are subject to change without notice.
3. We reserve the right to substitute functional replacements.
4. Order by Part No.; not Heater Option Designation.



Index of Parts by Page No.	Model FT	Model SFT
		
Burner Rack	7	9
Cabinet Parts	6	10
Downturn Air Outlet Nozzles (same as Options CD 2, 3, 4)	14	14
Electrical Components	2-5	8-9
Fan and Components	7	10
Fan Guard	7	10
Gas Conversion Kits	12	12
Heat Exchangers	7	11
Ignition Control Board	4-5	8
Ignitor	4-5	8
Limit Control	4-5	8
Louvers, Horizontal	6	10
Louvers, Vertical (same as Option CD1)	13	13
Manifold	7	9
Motor, Fan	7	10
Motor, Venter	2-5	8
Orifices, Burner	12	12
Rating Plate	1	1
Serial Number	2	2
Switch, Flame Rollout	4	9
Switch, Pressure	4-5	9
Thermostat	15	15
Transformer	4-5	9
Valve	4-5	8
Vent Cap (same as Option CC1)	7	--
Vent/Combustion Air Kits (same as Option CC2 and CC6)	--	11
Vent Tape (same as Option FA1)	15	15
Venter Parts	2-5	8

Additional References (use Form RZ designation to order literature; not the P/N)

Description/Application	Form RZ	P/N
Parts/Service - Replacement Gas Valves and Ignition Control Boards by Serial No. Code . P-VALVES		N/A
Service - Converting to Other Gases	FT/SFT-GC ..	148066
Installation/Operation - Model FT Heaters	I-FT ..	173473
Installation/Operation - <i>Special</i> Model FT-CV or FT-LN Unit Heaters	I-FT-CV/LN ..	177854
Installation/Operation - Model SFT Heaters	I-SFT ..	173474
Installation Instructions - Optional Vertical Louvers, Models FT and SFT	I-FT/SFT-VL ..	160807
Installation Instructions - Optional Downturn Nozzle, Models FT and SFT .	I-FT/SFT-DN ..	160808

Model FT and Model SFT Unit Heaters

INSTALLATION FORM RZ-NA-P-FT/SFT
Obsoletes Form RZ-728

APPLIES TO: Replacement Parts

Rating Plate and Serial No.

Example of a Rating Plate

REZNOR

MERCER, PA. USA 16137

MADE IN USA



UNIT HEATER

CATEGORY I I I

ANSI Z83.8 [A] CGA 2.6-M [A'] UNIT HEATER

CSA .10.96 U.S. (2nd Ed.) UNIT HEATERS FOR RESIDENTIAL INSTALLATION

MODEL [B] [C]

SERIAL NO.

[D] VOLTS [D] PH [D] HZ MAXIMUM TOTAL INPUT [D] AMPS

TYPE OF GAS: [E]

FOR USE AT [F] FEET [G] METERS OF ALTITUDE.

ORIFICE SIZE [H] DRILL HAS BEEN FACTORY ADJUSTED

	SEA LEVEL	ALT. ADJUSTED
NORMAL INPUT	[<u>I</u>]	[<u>J</u>] BTU/HR.
THERMAL OUTPUT CAPACITY	[<u>K</u>]	[<u>L</u>] BTU/HR.
NORMAL MANIFOLD PRESSURE		[<u>O</u>] IN.W.C.
MIN. PERMISSIBLE GAS SUPPLY PRESSURE FOR PURPOSE OF INPUT ADJUSTMENT.		[<u>P</u>] IN.W.C.

CLEARANCES TO COMBUSTIBLE CONSTRUCTION: TOP-1", FLUE CONNECTION-6", CONTROL SIDE-18", OPP. SIDE-1", BOTTOM-1"

FOR ALTERNATE INSTALLATIONS USE THE LATEST EDITIONS OF THE APPROPRIATE STANDARD LISTED BELOW:

FOR AIRCRAFT HANGARS USE STANDARD ANSI/NFPA 409
FOR PARKING STRUCTURES USE STANDARD ANSI/NFPA 88A
FOR REPAIR GARAGES USE STANDARD ANSI/NFPA 88B

THIS UNIT IS NOT FOR USE WITH DUCTS.

THIS UNIT IS NOT FOR USE WITH FILTERS.

CONSTRUCTION WALL THICKNESS FOR PURPOSE OF VENTING:

1" MIN., 30" MAX.

Rating Plate Key:

- A** = Date of ANSI Standard
- A'** = Date of CGA Standard
- B** = Model No.
- C** = Month and Year of Manufacture
- D** = 115V, 1 Phase, 60 Hertz, Maximum Total Input Amps
- E** = Natural or Propane Gas
- F/G** = Elevation (Feet/Meters)
- H** = Orifice Size
- I** = BTU Input Sea Level
- J** = BTU Input Altitude Adjusted
- K** = BTU Thermal Output Sea Level
- L** = BTU Thermal Output Altitude Adjusted
- O** = Manifold Pressure (3.5 w.c. Natural Gas; 10 w.c. Propane Gas)
- P** = Minimum Gas supply Pressure (5.0 w.c. Natural Gas; 11.0 w.c. Propane Gas)

Rating Plate and Serial No. (cont'd)

Decoding a Serial No.

Example of a Serial No.	BAB	75	W5	N	00000
Code Nos.	1	2	3	4	5
Code No.	Explanation				
1	Date of manufacture (see below)				
2	Type of pilot system (see Form RZ 714)				
3	Type of gas valve (see Form RZ 714)				
4	Gas (N = natural; L = propane)				
5	Consecutive number (identification only)				

First Element of the Serial Number - Date of Manufacture

Year	Jan	Feb	Mar	Apr	May	June	July	Aug	Sept	Oct	Nov	Dec
1995	AUA	AUB	AUC	AUD	AUE	AUF	AUG	AUH	AUI	AUJ	AUK	AUL
1996	AVA	AVB	AVC	AVD	AVE	AVF	AVG	AVH	AVI	AVJ	AVK	AVL
1997	AWA	AWB	AWC	AWD	AWE	AWF	AWG	AWH	AWI	AWJ	AWK	AWL
1998	AXA	AXB	AXC	AXD	AXE	AXF	AXG	AXH	AXI	AXJ	AXK	AXL
1999	AYA	AYB	AYC	AYD	AYE	AYF	AYG	AYH	AYI	AYJ	AYK	AYL
2000	AZA	AZB	AZC	AZD	AZE	AZF	AZG	AZH	AZI	AZJ	AZK	AZL
2001	BAA	BAB	BAC	BAD	BAE	BAF	BAG	BAH	BAI	BAJ	BAK	BAL
2002	BBA	BBB	BBC	BBD	BBE	BBF	BBG	BBH	BBI	BBJ	BBK	BBL
2003	BCA	BCB	BCC	BCD	BCE	BCF	BCG	BCH	BCI	BCJ	BCK	BCL
2004	BDA	BDB	BDC	BDD	BDE	BDF	BDG	BDH	BDI	BDJ	BDK	BDL
2005	BEA	BEB	BEC	BED	BEE	BEF	BEG	BEH	BEI	BEJ	BEK	BEL
2006	BFA	BFB	BFC	BFD	BFE	BFF	BFG	BFH	BFI	BFJ	BFK	BFL
2007	BGA	BGB	BGC	BGD	BGE	BGF	BGG	BGH	BGI	BGJ	BGK	BGL
2008	BHA	BHB	BHC	BHD	BHE	BHF	BHG	BHH	BHI	BHJ	BHK	BHL
2009	BIA	BIB	BIC	BID	BIE	BIF	BIG	BIH	BII	BIJ	BIK	BIL
2010	BJA	BJB	BJC	BJD	BJE	BJF	BJG	BJH	BJI	BJJ	BJK	BJL
2011	BKA	BKB	BKC	BKD	BKE	BKF	BKG	BKH	BKI	BKJ	BKK	BKL
2012	BLA	BLB	BLC	BLD	BLE	BLF	BLG	BLH	BLI	BLJ	BLK	BLL
2013	BMA	BMB	BMC	BMD	BME	BMF	BMG	BMH	BMI	BMJ	BMK	BML
2014	BNA	BNB	BNC	BND	BNE	BNF	BNG	BNH	BNI	BNJ	BNK	BNL
2015	BOA	BOB	BOC	BOD	BOE	BOF	BOG	BOH	BOI	BOJ	BOK	BOL

Model FT Control Compartment and Electrical Components

Code	Description	Qty	For heaters mfgd PRIOR TO residential approval (approx. 11/97*- verify on rating plate)		
			30	45	60
1A	Venter Housing Assy - standard heater (does not apply to Model FT with suffix CV or LN; see Code 1B)	1	147357		
1B	Venter Housing Assy - Size 30 or 45 heater with suffix CV (Option AV6) or LN (Option AL2B)	1	--	--	--
2	Venter Gasket (not illustrated)	1	147793		
3	Static Pressure Tap	1	116043		
*4	Venter Motor & Wheel Assy (includes Codes 4A-4D)	1	147359		
*4A	Venter Motor (**Sizes 150-200 is an assembly including motor, P/N 148053; capacitor, P/N 163894; and capacitor boot, P/N 103182)	1	97738 Magnetek #JA1M156N		
*4B	Venter Wheel	1	135979 Revcor B506-1005		
*4C	Venter Motor Plate	1	135981		
*4D	Venter Fan Blade	1	68005		

*11/97 is Serial No. Date Code AWK; but **always** verify actual type of approval stated on the rating plate.

Model FT

Control Compartment and Electrical Components - see P/N listings, pages 2-5

Model FT Control Compartment (A Size 30 is illustrated; locations are approximately the same for other sizes but may appear out of proportion.)

11 - Limit Control - Sizes 30-75 (Located in the heat exchanger compartment; remove louvers to access.)

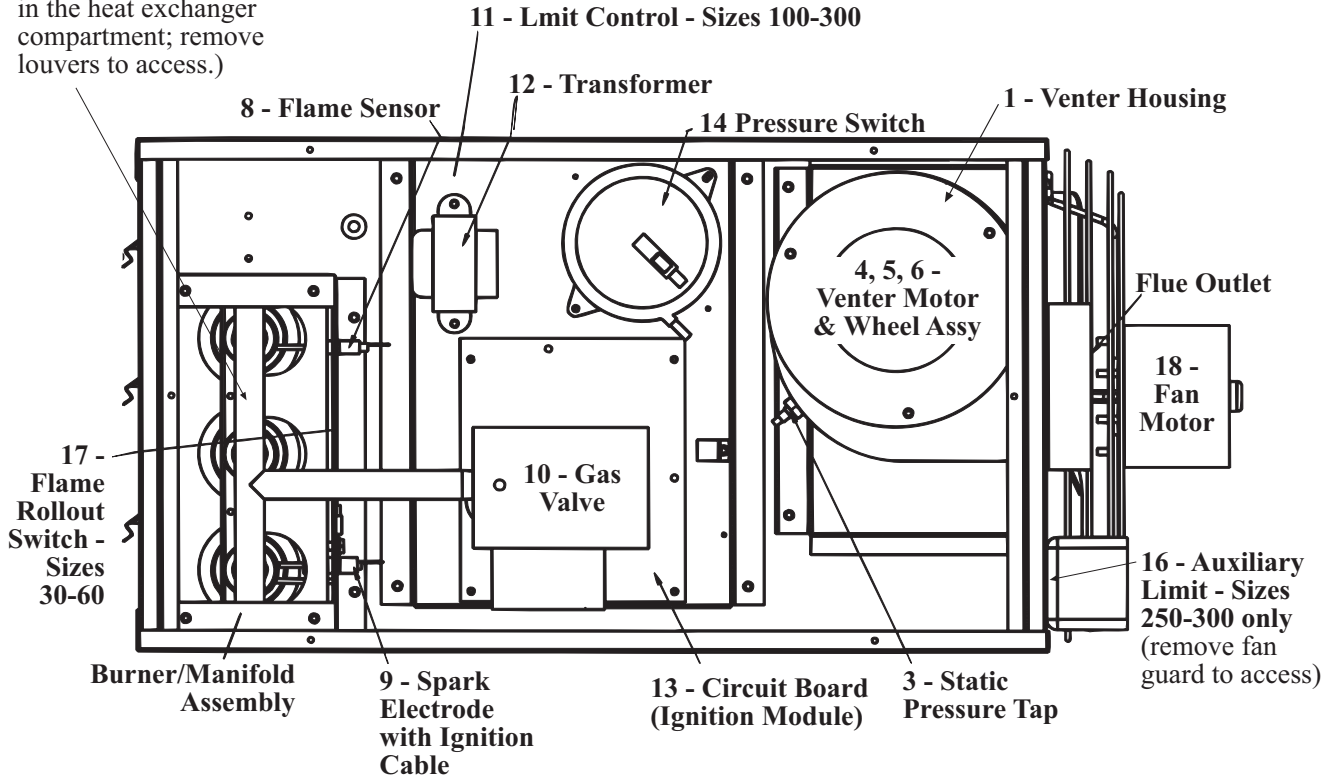

NOTE: If the heater has been changed so that the controls are on the left side, their locations will appear inverted. On Sizes 60-300, the ignitor *must* still be toward the bottom of the heater with the flame sensor toward the top.

Code	For heaters WITH residential approval (mfgd beginning approx 11/97* - verify on rating plate)			75	100	125	150	200	250	300
	30	45	60							
1A	164689 (replaces 158435)	164690 (replaces 158436)	164691 (replaces 158448)	147357			147657		149164	149165
1B	176809	176309	--	--	--	--	--	--	--	--
2	147793	44695		147793			97300			
3	P/N 116043 is part of Vntr Housing, Code 1A			116043						
*4	147359			148056		148057		149160		
*4A	148055 Magnetek #JA1M213N (replaces P/N 97738, Magnetek #JA1M156N)			148055 Magnetek #JA1M213N		**148980 Includes P/N 148053, Magnetek #JE1E024N		150771 Magnetek #JE1F022		
*4B	135979 Revcor B506-1005			97724 Brookside #FE-400-200-2		135980 Brookside #FE610-200-1				
*4C	135981			97301		164380				
*4D	68005			141570 (replaces 68005 on 250/300)						

continued on the next page

Model FT Electrical Components (cont'd) - Refer to the illustration on page 3

Code	Description (cont'd)	Qty	For heaters mfgd <i>PRIOR TO</i> residential approval (approx. 11/97*- verify on rating plate)			For heaters <i>WITH</i> residential approval (beginning approx. 11/97* - verify on rating plate)			
			30	45	60	30	45	60	
5	Venter Mtr & Wheel Assy (includes Codes 5A-5G) - Size 30 or 45 heater with suffix CV (Option AV6) only	1	--	--	--	177148		--	
5A	Venter Motor	Apply to Model FT with suffix CV (Option AV6)	1	--	--	175987 Magnetek #JA2N297		--	
5B	Venter Wheel		1	--	--	135979 Revcor B506-1005		--	
5C	Venter Motor Plate		1	--	--	176311		--	
5D	Venter Motor Plate Gasket		1	--	--	155651		--	
5E	Secondary Motor Plate		1	--	--	176810		--	
5F	Spacers		4	--	--	98872		--	
5G	Venter Fan Blade		1	--	--	68005		--	
6	Vntr Mtr & Wheel Assy (includes Codes 6A-6G) - Size 45 heater with suffix LN (Option AL2B) only	1	--	--	--	176329	--		
6A	Venter Motor	Apply to Model FT with suffix LN (Option AL2B)	1	--	--	--	175987 Magnetek #JA2N297	--	
6B	Venter Wheel		1	--	--	--	135979 Revcor B506-1005	--	
6C	Venter Motor Plate		1	--	--	--	176311	--	
6D	Venter Motor Plate Gasket		1	--	--	--	155651	--	
6E	Isolator, rubber w/brass insert		4	--	--	--	113498	--	
6F	Isolator Plate		1	--	--	--	176310	--	
6G	Venter Fan Blade		1	--	--	--	68005	--	
7	Vntr Inlet Ring - Size 45 with suffix CV or LN only	1	--	--	--	62594	--		
8	Flame Sensor, Channel Products #1259-85	1	147165			147165		--	
9A	Spark Ignitor with Cable - applies only to heaters with Johnson Controls G861 Ignition Control Board, P/N 174260 (Code 13)	1	159956 (assembly replaces both 147166 and 147167)						
9B	Spark Ignitor	use w/RAM 3MC4 ignition cntrl board	1	147166			147166		
	Ignition Cable		1	147167			147167		
10	Gas Valve NOTE: Identify the valve on the heater by manufacturer's no. and the Serial No. code on page 2.	Natural Gas	1	172552, M/H VR8105M2187 (replaces 147133, Robertshaw #7222 DER; field-supplied piping is required)			172552, M/H VR8105M2187		
		Propane Gas	1	172553, M/H VR8105M2825 (replaces 147134, Robertshaw #7222 DERLP; field-supplied piping is required)			172553, M/H VR8105M2825		
11	Limit Control, Thermdisc #36T (access by removing louvers)	1	45602 180°F			45602 180°F			
12	Transformer, 30 VA, #4000-01M04BB80	1	147356			147356			
13	Ignition Control Board, J/C G861	1	174260 (replaces P/N 147102 and may be used with either Code 9A or 9B; if replacing board and ignitor, order Code 9A)						
14A	Pressure Switch - applies to standard heater (for Size 30 or 45 with suffix CV or LN, see Code 14B)	up to 4000 ft	1	148072 TDI #PPS10027-2228		164672 TDI #PPS10027-2731 (replaces 159180)	164673, TDI #PPS10027-2732 (replaces 148072)	(replaces 149879)	
		4001-9000 ft	1	149879 TDI #PPS10027-2355		164674 TDI #PPS10027-2733 (replaces 159181)	164675, TDI #PPS10027-2734 (replaces 148072)	(replaces 159179)	
14B	Pressure Switch - applies to Sizes 30 and 45 with Suffix CV or LN only	up to 4000 ft	1	--	--	--	164672 TDI #PPS10027-2731	--	
		4001-9000 ft	1	--	--	--	164674 TDI #PPS10027-2733	--	
15	Silicone Rubber Tubing for Pressure Sensing (not illustrated)	1	147904 7" long		147905 9" lg	147904 7" long		147905 9" long	
16	Auxiliary Limit Control (remove fan guard to access)	1	--	--	--	--	--		
17	Flame Rollout Switch (manual reset)	Std FT & suffix CV	1	--	--	--	121275, 275°F	112752, 225°F	121275, 275°F
		Model FT45-LN only	1	--	--	--	--	121275, 275°F	--
18	Fan Motor - See Code 39C for standard Model FT or Model FT with suffix CV; see Code 40C for Model FT with suffix LN	1	--	--	17782	--	--	--	
19	Outlet Box, 2x4, Steel City #58361	1	--	--	17782	--	--	--	
20	Outlet Box Cover	1	--	--	17800	--	--	--	

Code	75	100	125	150	200	250	300
5	--	--	--	--	--	--	--
5A	--	--	--	--	--	--	--
5B	--	--	--	--	--	--	--
5C	--	--	--	--	--	--	--
5D	--	--	--	--	--	--	--
5E	--	--	--	--	--	--	--
5F	--	--	--	--	--	--	--
5G	--	--	--	--	--	--	--
6	--	--	--	--	--	--	--
6A	--	--	--	--	--	--	--
6B	--	--	--	--	--	--	--
6C	--	--	--	--	--	--	--
6D	--	--	--	--	--	--	--
6E	--	--	--	--	--	--	--
6F	--	--	--	--	--	--	--
6G	--	--	--	--	--	--	--
7	--	--	--	--	--	--	--
8	147165						
9A	159956 (assembly replaces both 147166 and 147167)			159957 (assembly replaces both 147166 and 148085)			
9B	147166						
	147167			148085			
10	172552, M/H VR8105M2187 (replaces 147133, Robertshaw #7222 DER; field-supplied piping is required)		147830 M/H #VR8205M1130		150839 M/H #VR8305-M4009		
	172553, M/H VR8105M2825 (replaces 147134, Robertshaw #7222 DERLP; field-supplied piping is required)		147560 M/H #VR8205M1148		150840 M/H #VR8305M4017		
11	45602 180°F		155764 (replaces 96512) 220°F, Blue Dot		155765 (replaces (85449)) 200°F, Yellow Dot		
12	147356						
13	174260 (replaces P/N 147102 and may be used with either Code 9A or 9B; if replacing board and ignitor, order Code 9A)						
14A	148072 TDI #PPS10027-2228					150837 TDI # PPS10027-2392	
	149879 TDI #PPS10027-2355					151372 TDI # PPS10027-2406	
14B	--	--	--	--	--	--	--
	--	--	--	--	--	--	--
15	147905 9" long		148251 12" long				
16	--	--	--	--	100799, 150°F		
17	--	--	--	--	--	--	--
18							
19	--	--	--	--	17782		
20	--	--	--	--	17800		

**Model FT -
Cabinet and
Heat Exchanger
Parts**

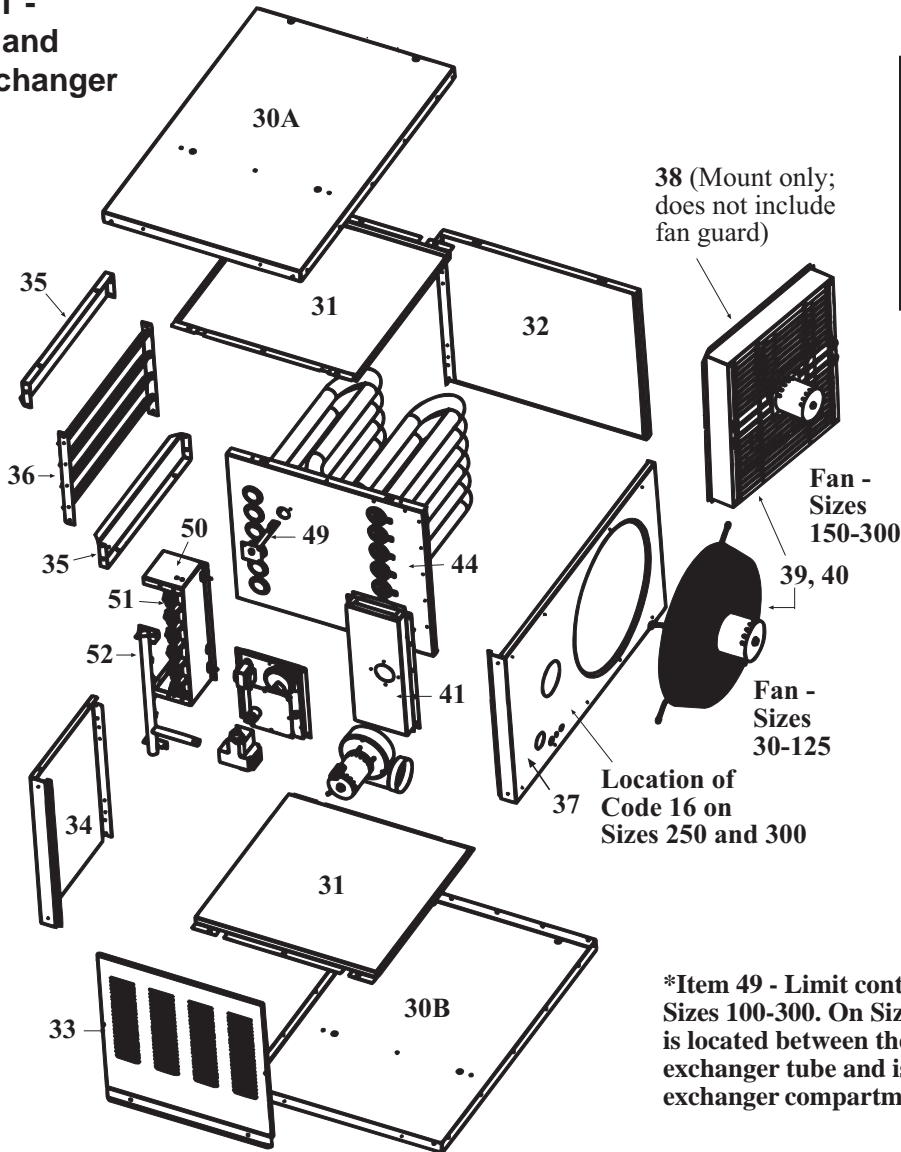

*Item 49 - Limit control location shown is for Sizes 100-300. On Sizes 30-75, the limit control is located between the first and second heat exchanger tube and is accessible from the heat exchanger compartment.

Code	Description	Qty	For heaters mfgd PRIOR TO residential approval (approx. 11/97*- verify on rating plate)			For heaters WITH residential approval (mfgd beginning approx. 11/97*- verify on rating plate)			75	100	125	150	200	250	300	
			30	45	60	30	45	60								
			30A	Top Outer Panel	Mfgd after 3/99	1	147105	147225								147105
		Mfgd before 3/99	1	175827	175833	175827	175833			146455				148680		
30B	Bottom Outer Panel	Mfgd after 3/99	1	147106	147226	147106	147226									
		Mfgd before 3/99	1	175828	175834	175828	175834			146455				148680		
31A	Top/Bottom Retainer Panel		2	147155	147223	147155	147223			146615				--	--	
31B	Small Top/Btm Retainer Panel		2	--	--	--	--	--	--	--	--	--	--	148591		
31C	Large Top/Btm Retainer Panel		2	--	--	--	--	--	--	--	--	--	--	148616		
32	Left Side Panel Assembly (Outer Panel & Retainer)		1	147574	147575	147574	147575		147816		147817			150977		
33	Access Panel		1	147115	147116	147115	147116	147116	146490				146479			
34	Right Front Panel	Mfgd after 3/99	1	--	--	--	147113	147837	147114	147838						
		Mfgd before 3/99	1	175829	175830	175835	175829	175830	175835	175836	146492		146493		148681	
35	Top/Bottom Front Panels		2	--	--	--	--	--	--	--	147847	146476	147848	146477	150992	148682
36	Louver Assembly		1	147426	147427	147426	147427		147850	131803		94865		151595		
37	Fan Back	Mfgd after 3/99	1	--	--	147108	158734	147586								
		Mfgd before 3/99	1	175826	175831	175826	175831	175832	148924			147158		148685		
38	Fan Guard Mount Assembly		1	--	--	--	--	--	--	--		147835		150990		

Code	Description	Qty	For heaters mfgd PRIOR TO residential approval (approx. 11/97* - verify on rating plate)			For heaters WITH residential approval (mfgd beginning approx. 11/97* - verify on rating plate)			75	100	125	150	200	250	300
			30	45	60	30	45	60							
39	Fan, Fan Guard & Mtr Assy (includes Codes 39A-39C) - applies to standard Model FT and Model FT with CV suffix (for heater with LN suffix, see Code 40)	1	147181	147182	147183	147181	147182	147183	147672	147672	147673	150997			
39A	Fan Guard	1	151991 (replaces 147185)		151992 (replaces 147157)	151991 (replaces 147185)		151992 (replaces 147157)	136949, 18" round (replaces 45616)		104818, 20" square, flat				
39B	Fan Blade - applies to standard FT or Model Ft with CV suffix (for heater with LN suffix, see Code 40B)	1	129853 Revcor #01005-34		125566 Lau F07H07 15.75-31	129853 Revcor #01005-34		125566 Lau F07H07 15.75-31	141598 Lau #610257-01	150155 Revcor T2004-33	150838 Lau Y10S08A 2436				
39C	Fan Motor - applies to standard FT or Model Ft with CV suffix (for heater with LN suffix, see Code 40C)	1	147103 Magnetek #JA2N	147104 Magnetek #JA2R	150332 Smith #F42A 53A13, 1/20HP (replaces 95547)	147103 Magnetek #JA2N	147104 Magnetek #JA2R	150332 A. O. Smith #F42A53A13, 1/20HP (replaces 95547)	147908 A. O. Smith #F42C81A13, 1/6HP	147913 A. O. Smith #F48H01A13, 1/4HP	156275 Magnetek HE4T005, 1/2HP (replaces 100589)				
40	Fan, Fan Guard, and Mtr Assy (includes Codes 40A-40C) - applies to Model FT with LN suffix only	1	--	--	--	--	176490	--	--	--	--	--	--	--	
40A	Fan Guard	1	--	--	--	--	151991	--	--	--	--	--	--	--	
40B	Fan Blade - applies to Model FT with LN suffix only	1	--	--	--	--	129853, #01005-34	--	--	--	--	--	--	--	
40C	Fan Motor - applies to Model FT with LN suffix only	1	--	--	--	--	175988, Magnetek 2E3C002	--	--	--	--	--	--	--	
41A	Flue Wrapper Assy - standard Model FT and Model FT with suffix LN (for Size 30 and 45 with CV suffix, see 41B)	1	147444	147445	147446	158433	158434	158442	147447	147911	147649	147880	147650	150995	150996
41B	Flue Wrapper Assy - applies to heaters with CV suffix only	1	--	--	--	176817	158434	--	--	--	--	--	--	--	
42	Top/Btm Flue Gasket	2	147394		147395	147394		147395	147651						
43	Side Flue Gasket	2	147227	147228	147229	147227	147228	147230	147882	147652	147855	147653	147855	147653	
44	Heat Exchanger/Turbulator/ Inner Panel Assy	1	148067	148068	148069	148067	148068	148069	148070	157939	157940	157941	157942	157943	157944
45	Mid-Tube Support (heat exchanger)	1	--	--	--	--	--	--	--	--	--	--	--	148618	
46	Mid-Tube Support Bracket	2	--	--	--	--	--	--	--	--	--	148619			
47	Tube Clamp	1	--	--	--	--	--	--	--	--	--	155264	--	--	
49	Limit Control Bracket	1	--	--	--	147221				--	--	--	--	--	
50	Burner Box	1	147057	147058	147063	158441	158424	158425	147064	146473		146474		148684	
51	Burner Rack Assy (includes 51A, 51B, and 51C)	1	147577	147578	147579	147577	147578	147579	147580	147822	147823	147824	147825	150783	150784
51A	Burner	Qty >	147132 Beckett #X783			147132 Beckett #X783			147132 Beckett #X783					150836 Beckett #10924X	
51B	Burner Support Slot	1	147566	147567	147568	147566	147567	147568	147569	146482		146484			
51C	Burner Clamp	1	150184	105185	150153	150184	105185	150153	149595	146481		146483			
52	Manifold (less orifices)	1	147003	147004	147136	147003	156094	156095	156096	151785	151786	151787	151788	151787	151788
53	Burner Orifices - See Table on page 12.														
54	Hanger Angle Sub-Assembly	2	--	--	--	--	--	--	--	--	--	--	--	--	150991
55	Vent Cap (Same as Option CC1)	1	111848 4" diameter			111848 4" diameter			111849 5" diameter			111850 6" dia			

* 11/97 is Serial No. Date Code AWK (see page 1); but **always** verify actual type of approval stated on the rating plate before selecting replacement parts.

Model SFT - Electrical and Burner Box Components

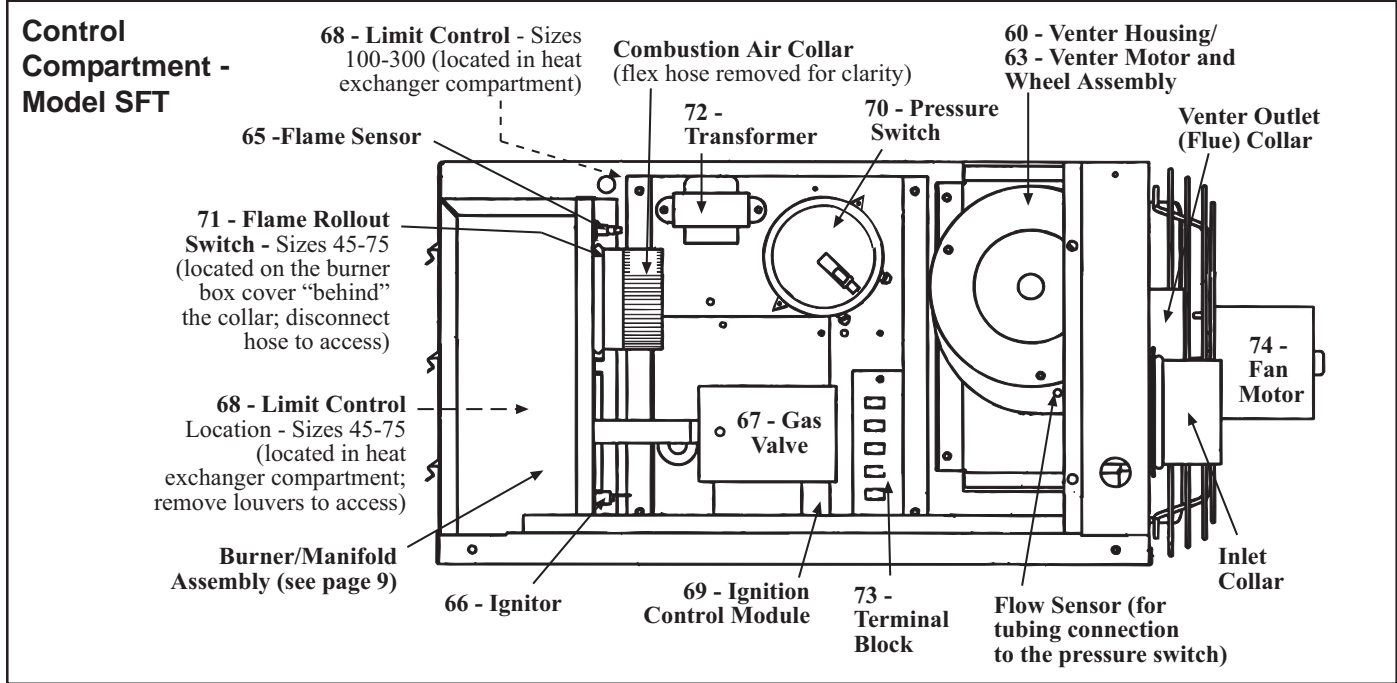

Code	Description	Qty	45	60	75	100	125	150	200	250	300
60	Venter Housing Assembly	1	156854		156855			156856	156857		157289
61	Venter Gasket (not illustrated)	1	147793		155650				155649		
62	Flow Sensing Probe Assy (not illustrated)	1					148978				
63	Venter Motor & Wheel Assy (includes Codes 63A-63H) - Code 64 required with 63)	1	156472		155980				155981		
63A	Venter Motor	1			148980				150771		
					Includes motor P/N 148053, Magnetek #JE1E024N, and Codes 63B & 63C				Magnetek #JE1F022N		
63B	Capacitor, 4MFD @ 370V	1			163894			-	-	-	-
63C	Capacitor Boot	1			103182			-	-	-	-
63D	Venter Wheel	1	135979 Revcor B506-		155271				135980		
					Brookside #FE610-119-1				Brookside #FE610-200-3		
63E	Venter Motor Plate (Code 64 required with 63E)	1	135981					151515			
63F	Venter Fan Blade	1			68005, 2.25" dia, 5/16" bore			141570, 2.25" dia., 3/8" bore			
63G	Spiral Spacer	4			97722 - #8 x 15/16" long			97721 - #8 x 3/4" long			
63H	Nut #8-32	4					31522				
64	Venter Motor Plate Gasket	1	155651					155652			
65	Flame Sensor - Channel #1259-85	1					147165				
66A	Spark Ignitor with Cable - applies only to heaters with Johnson Controls G861 Ignition Control Board, P/N 174260 (Code 69)	1			159956 (assembly replaces both 147166 and 147167)			159957 (assembly replaces both 147166 and 148085)			
66B	Spark Ignitor	1					147166				
	use with RAM 3MC4 ignition control board										
	Ignition Cable	1			147167			148085			
67	Gas Valve	1			172552, M/H #VR8105M2187	147830, M/H #VR8205M1130		147830, M/H #VR8205M1130		150839, M/H #VR8305M4009	
	Natural Gas				(replaces 147133, Robertshaw #7222DER; field-supplied piping is required)						
	NOTE: Identify the valve on the heater by the manufacturer's no. and the Serial No. code on page 1.										
	Propane Gas	1			172553, M/H #VR8105M2825	147560, M/H #VR8205M1148		147560, M/H #VR8205M1148		150840, M/H #VR8305M4017	
					(replaces 147134, Robertshaw #7222DERLP; field-supplied piping is required)						
68	Limit Control & Bracket Assy (includes 68A)	1		155985			147670			151516	
68A	Snap Disk Limit Control	1		45602 - 180°F			155764 - 220°F			155765 - 200°F	
				TOD 60T11-201614			TOD 36TV21-13878			TOD 36TV21-13879	
69	Ignition Control Board, J/C G861	1	174260 (replaces P/N 147102 and may be used with either Code 66A or 66B; if replacing board and ignitor, order Code 66A)								

Code	Description	Qty	45	60	75	100	125	150	200	250	300
70A	Pressure Switch, TDI #FS6210A	1	173312, -0.60 w.c. (replaces 156302)			173311, -0.40 w.c. (replaces 156301)		173313, -0.65 w.c. (replaces 156303)			
70B	High Altitude Pressure Switch (above 4000 ft)	1	173316, -0.55 w.c. (replaces 157278)			173315, -0.35 w.c. (replaces 157277)		173312, -0.60 w.c. (replaces 156302)			
71	Flame Rollout Switch, TOD #36T26-662, 180°F	1	157282			-	-	-	-	-	-
72	Transformer, 30VA, Products 4000-01-M04BB80	1	147356								
73	Terminal Board, Doran	1	151600								
74	Fan Motor - See Code 113C										
75	Tubing from pressure switch to pressure tap	1	174399 - 13"			151564 - 17"					
76	Tubing from pressure switch to probe	1	133117 - 11"			155377 - 15"					

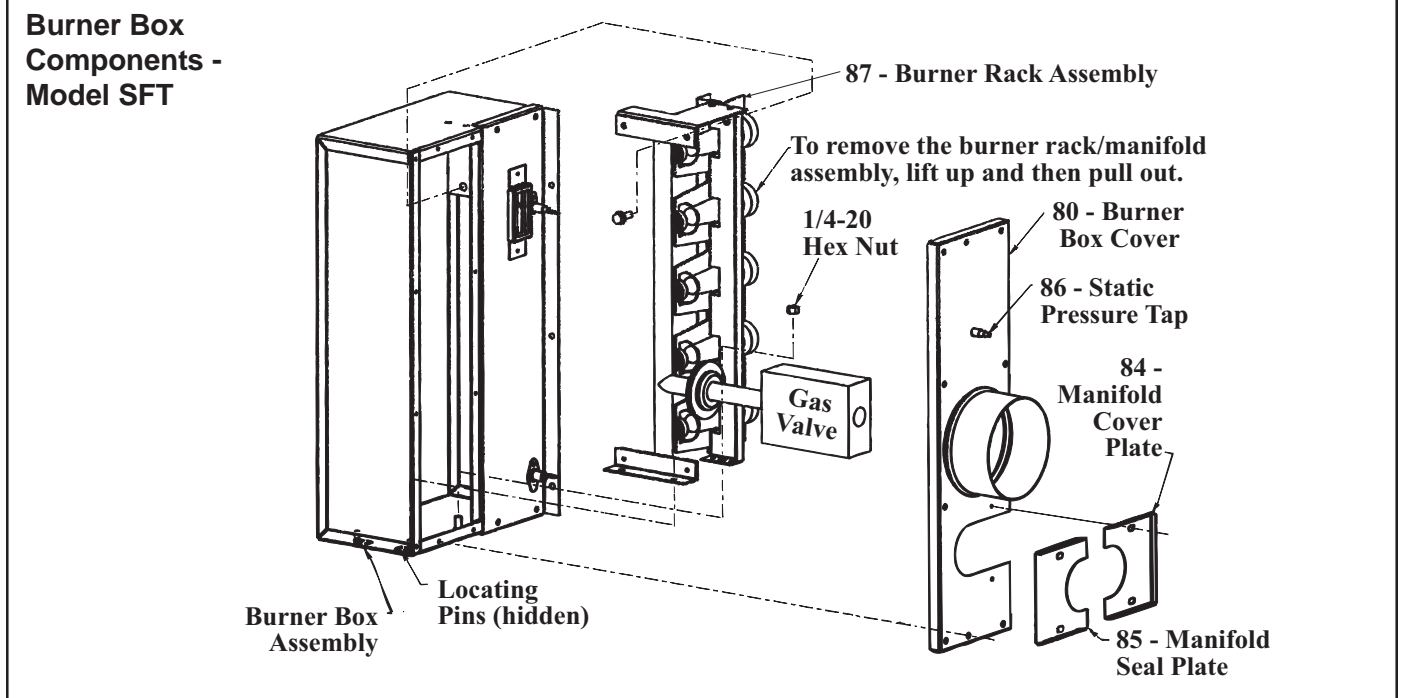

Code	Description	Qty	45	60	75	100	125	150	200	250	300	
80	Burner Box Cover Assy (includes flue collar)	1	157286	157287	157288	156029		156030		156031		
81	Neoprene Gaskets	1	155607	155606	156605	155608			155609			
82	inside Burner Box	2		155615		155616		155617		155618		
83	(not illustrated)	1	155612	155611	155610	155613			155614			
84	Manifold Cover Plate	1		155340			151828			155340		
84A	Manifold Cover Plate Gasket (not illustrated)	1		157008			157007			157008		
85	Manifold Seal Plate	1				157162						
86	Static Pressure Tap, TD #AA3743 (on Code 80)	1				116043						
87	Burner Rack Assy (located behind Code 80) (Includes Codes 87A, 87B, 87C - not illustrated)	1	155851	155852	155853	155855	155856	160506	160507	155858	155859	
87A	Burner	Qty →	(3)	(4)	(5)	(5)	(6)	(8)	(10)	(8)	(10)	
			147132 Beckett #X783								150836 Beckett #10924X	
87B	Burner Support Slot	1	150187	150154	149596	146482				146484		
87C	Burner Clamp	1	150185	150153	149595	146481				146483		
88	Igniter/Flame Sensor Cover with Viewports	1	156018	156019	156020	156011	156021	156022	156023	156024	156025	
89	Manifold (less orifices) - behind Code 80	1	156094	156095	156096	151785	151786	151787	151788	151787	151788	
90	Burner Orifices - See Table on page 10.											
91	Fiberglass Gaskets for between Burner Box Sides & Heat Exchanger Assy Panel (not illustrated)	2	155619	155620	155621	155622			155623			
92	Fiberglass Gaskets for between Burner Box Top & Btm & Heat Exchanger Assy Panel (not illustrated)	2	155624			155625						
93	Flexible Combustion Air Hose - 18" long (not illustrated)	1	155408 3" dia.	155409 4" diameter		155410 5" diameter			155411 6" diameter			
94	Worm Clamps for Code 93 (not illustrated)	2	155319	120716		155320			155321			

Model SFT Cabinet and Heat Exchanger Parts

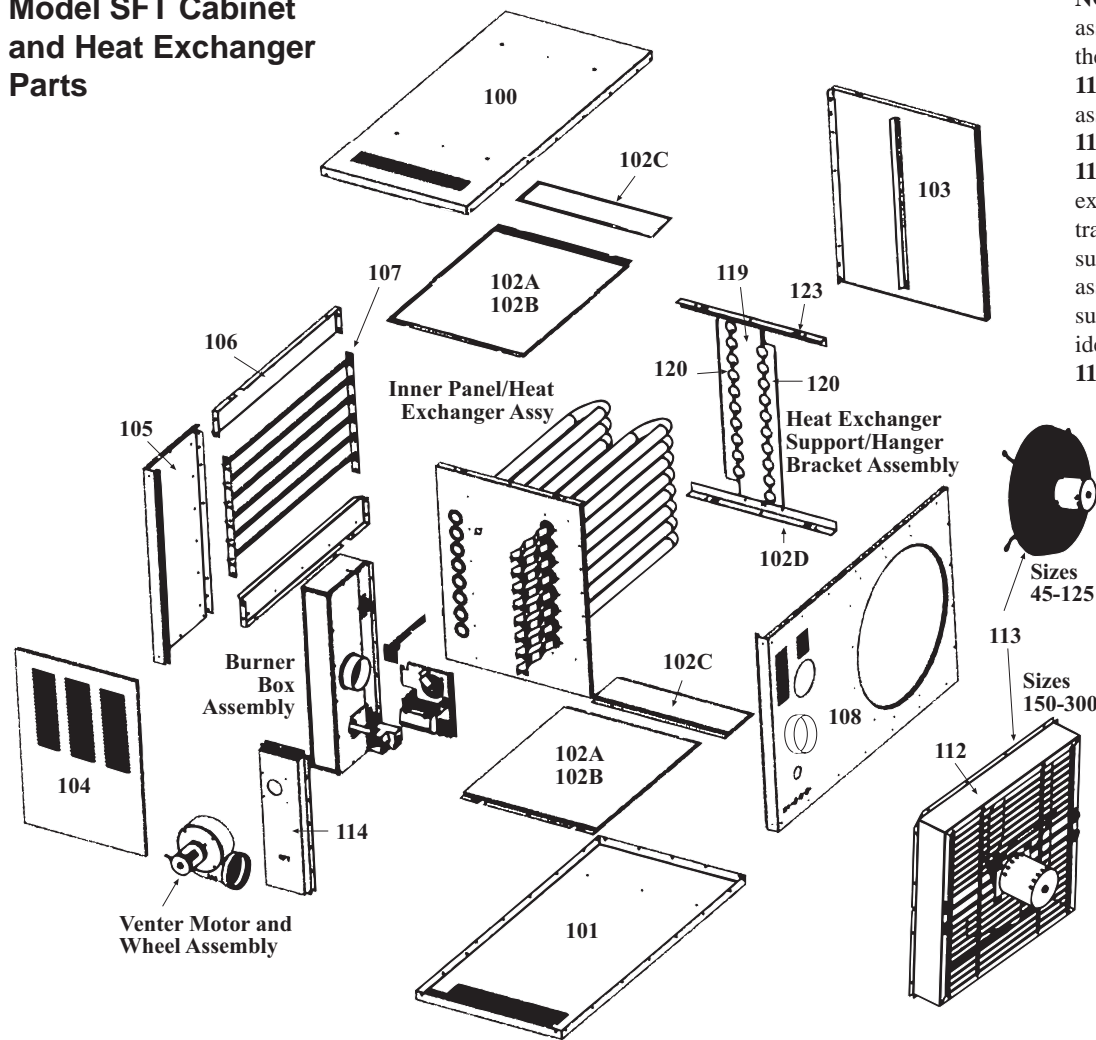

NOTES: The fan and motor assembly is not exploded; the fan guard mount (Code 112) is not part of the assembly identified as Code 113. Turbulators (Code 118) slide into the heat exchanger tubes as illustrated. The heat exchanger support/hanger bracket assembly is shown here as a subassembly. Parts are identified separately (Codes 119, 120, 123 and 102D).

Code	Description	Qty	45	60	75	100	125	150	200	250	300
100	Top Outer Panel	Units mfgd beginning 10/00	1	147105	147225			146455			148680
		Units mfgd prior to 10/00	1	155286	151832			151760			155128
101	Bottom Outer Panel	Units mfgd beginning 10/00	1	147106	147226			146455			148680
		Units mfgd prior to 10/00	1	155287	151833			155289			155339
102A	Top/Bottom Retainer Panel		2	147155	147223			146615		-	-
102B	Large Top/Bottom Retainer Panel		2	-	-	-	-	-	-	-	148616
102C	Small Top/Bottom Retainer Panel		2	-	-	-	-	-	-	-	148591
102D	Bottom Support (Hanger) Angle		1	-	-	-	-	-	-	-	148617
103	Left Side Panel Assy (Outer Panel, Air Deflector, and Retainer)		1	157010	157011	157013		157014			150977
104	Access Panel	Units mfgd beginning 10/00	1	147115	147116	146490				146479	
	Hinged Door Assembly	Units mfgd prior to 10/00, Includes Latch, P/N 156245	1	178422	178423	178428		178429		178430	178431
105	Right Front Panel	Units mfgd beginning 10/00	1	147837	147114 147838	146492		146493			148681
		Units mfgd prior to 10/00	1	155283	151829	155095		151761			155275
106	Top/Bottom Front Panel		2	-	-	147847	146476	147848	146477	150992	148682
107	Louver Assembly	Units mfgd beginning 10/00	1	147426	156082	147850	131803	94865			151595
		Units mfgd prior to 10/00	1		147427						
108	Fan Back Assy (includes collar)	Units mfgd beginning 10/00	1	156246	156247	156003		156004		156005	156006
		Units mfgd prior to 10/00	1	178422	178423	178428		178429		178430	178431
112	Fan Guard Mount Assembly		1	-	-	-	-	147835			157912
113	Fan, Fan Guard & Mtr Assy (113A-C)		1	147182	147183	147672		147673			150997
113A	Fan Guard		1	151991, 10"	151992, 16"	136949, 18"		104818, 20" square, flat			
113B	Fan Blade		1	129853 Revcor #01005-34	125566 Lau F07H07 15.75-31	141598 Lau #610257-01		150155 Revcor #T2004-33			150838 Lau Y10S08A 2436

Code	Description	Qty	45	60	75	100	125	150	200	250	300
113C	Fan Motor	1	147104 Magnetek #JA2R	150332 A. O. Smith #B42A53A13, 1/20HP	147908 A. O. Smith #F42C81A13, 1/6HP	147913 A. O. Smith #F48H01A13, 1/4HP	156275 1/2HP, Magnetek HE45005 (replaces 100589)				
114	Flue Wrapper Assembly	1	156840	156841	156843	156845	156847	156849	156851	156852	156853
115	Top/Bottom Flue Wrapper Gasket	(not illustrated)	2	147394	147395	147395	147651	147651	147651	147651	147651
116	Side Flue Wrapper Gasket		2	147228	147229	147230	147882	147652	147855	147653	147855
117	Heat Exchanger/Inner Panel Assembly	1	157936	157937	157938	157939	157940	157941	157942	157943	157944
118	Turbulators (Size 45, 60 & 75 turbulator are "square" assemblies)	Qty >	(3)	(4)	(5)	(5)	(6)	(8)	(10)	(8)	(10)
119	Mid-Tube Support (heat exchanger)	1	-	-	-	-	-	-	-	-	148618
120	Mid-Tube Support Bracket	2	-	-	-	-	-	-	-	-	148619
121	Tube Clamp	(not illustrated)	1	-	155388	155108	-	-	155264	-	-
122	Tube Clamp Bracket		2	-	155348	155101	-	-	-	-	-
123	Hanger Angle Sub-Assembly	2	-	-	-	-	-	-	-	-	150991

Model SFT Separated-Combustion Venting and Combustion Air System Parts

Codes 130A and 131A - Concentric Adapter Box Assembly

View of Heater Connection Side



Collar for attaching the combustion air pipe from the heater

Opening for vent pipe from the heater. Seal with rubber gasket. The vent pipe extends through the box.

View of Vent Terminal Connection Side



Collar for attaching the outside portion of the combustion air pipe (the vent pipe runs concentric through the outside portion of the combustion air pipe)

(NOTE: Concentric adapter boxes manufactured prior to 2/01 had a collar on the "heater connection side" to attach the vent pipe. There was a factory-installed length of vent pipe through the box. If replacing a concentric adapter box manufactured prior to 2/01, the field-supplied vent pipe must be extended through the new box. **Code 130E or 131F, rubber gasket, is required** to seal the opening around the vent pipe as it extends into the box.

Code 130B - Exhaust Terminal (Vertical Kit)



Code 130C - Combustion Air Inlet (Vertical Kit)



Code 130 - Vertical Vent Terminal/Combustion Air Package (Option CC2) includes:

Code	Qty	SFT	P/N	Description
130	1	45-125	157155	Complete Vertical Vent Kit (Same as Option CC2)
		150-250	157156	
		300	54444	
130A	1	45-125	155118	Concentric Adapter Box Assembly
		150-250	155392	
		300	68404	
130B	1	45-250	155631, 4"	Exhaust Terminal Cap
		300	53326, 5"	
130C	1	45-250	155635, 6"	Combustion Air Inlet
		300	53330, 8"	
130D	1	45-300	53335	3 oz Tube of High Temperature (450°F) Silicone Sealant
130E	1	45-250	164492, 4"	Rubber Seal (blue) for Exhaust Pipe
		300	164493, 5"	

Code 131B - Screened Exhaust Assembly (Horizontal Kit)



Code 131C - Inlet Guard (Horizontal Kit)



Code 131 - Horizontal Vent Terminal/Combustion Air Package (Option CC6) includes:

Code	Qty	SFT	P/N	Description
131	1	45-125	157157	Complete Horizontal Vent Kit (Same as Option CC6)
		150-250	157158	
		300	82131	
131A	1	45-125	155118	Concentric Adapter Box Assembly
		150-250	155392	
		300	68404	
131B	1	45-250	155096, 4"	Screened Exhaust Assembly
		300	53316, 5"	
131C	1	45-250	151755, 6"	Inlet Guard
		300	124940, 8"	
131D	4	45-300	37661	#10-16 x 1/2" Screws (for attaching inlet guard)
131E	1	45-300	53335	Tube of High Temperature Silicone Rubber Sealant
131F	1	45-250	164492, 4"	Rubber Seal (blue) for Exhaust Pipe
		300	164493, 5"	

Burner Orifice Chart - Models FT and SFT

IMPORTANT NOTE: If the manifold pressure has been adjusted at the valve for high altitude operation, the standard sea level burner orifices apply. The high altitude orifices in the table apply only to units purchased with a factory installed high altitude option. Check the rating plate to determine at what altitude the unit was manufactured to operate.

Models FT and SFT			30	45	60	75	100	125	150	200	250	300	
BURNER ORIFICES		Quantity	2	3	4	5	5	6	8	10	8	10	
Natural Gas, 0-2000 ft, installed in U.S. or Canada			P/N	40414	40414	40414	40414	11833	11833	38678	11833	97362	97362
			Size	#48	#48	#48	#48	#44	#44	#45	#44	#36	#36
Propane Gas, 0-2000 ft, installed in U.S. or Canada			P/N	63922	63922	63922	63922	11830	11830	64676	11830	96344	51284
			Size	1.15mm	1.15mm	1.15mm	1.15mm	#55	#55	1.3mm	#55	1.65mm	#52
Installed in Canada	Natural Gas	2001-4500 ft	P/N	39651	39651	39651	39651	38678	38678	84853	38678	45870	45870
			Size	#49	#49	#49	#49	#45	#45	#47	#45	#38	#38
	Propane Gas	ft	P/N	39659	39659	39659	39659	11830	11830	97359	11830	61653	9789
			Size	#58	#58	#58	#58	#55	#55	1.25mm	#55	1.55mm	#53
Installed in U.S.	Natural Gas	2001-3000 ft	P/N	39651	39651	39651	39651	38678	38678	16590	38678	11835	11835
			Size	#49	#49	#49	#49	#45	#45	#46	#45	#37	#37
	Propane Gas	ft	P/N	63922	63922	63922	63922	11830	11830	97359	11830	51284	51284
			Size	1.15mm	1.15mm	1.15mm	1.15mm	#55	#55	1.25mm	#55	#52	#52
	Natural Gas	3001-4000 ft	P/N	39651	39651	39651	39651	38678	38678	84853	38678	45870	45870
			Size	#49	#49	#49	#49	#45	#45	#47	#45	#38	#38
	Propane Gas	ft	P/N	63922	63922	63922	63922	11830	11830	97359	11830	61653	9789
			Size	1.15mm	1.15mm	1.15mm	1.15mm	#55	#55	1.25mm	#55	1.55mm	#53
	Natural Gas	4001-5000 ft	P/N	39651	39651	39651	39651	38678	38678	84853	38678	45870	45870
			Size	#49	#49	#49	#49	#45	#45	#47	#45	#38	#38
	Propane Gas	ft	P/N	39659	39659	39659	39659	11830	11830	97359	11830	61653	9789
			Size	#58	#58	#58	#58	#55	#55	1.25mm	#55	1.55mm	#53
	Natural Gas	5001-6000 ft	P/N	39652	39652	39652	39652	16590	16590	84853	16590	45871	45871
			Size	#50	#50	#50	#50	#46	#46	#47	#46	#39	#39
	Propane Gas	ft	P/N	39659	39659	39659	39659	39658	39658	63003	39658	9789	9789
			Size	#58	#58	#58	#58	#56	#56	1.2mm	#56	#53	#53
	Natural Gas	6001-7000 ft	P/N	39652	39652	39652	39652	84853	84853	40414	84853	87391	87391
			Size	#50	#50	#50	#50	#47	#47	#48	#47	#40	#40
	Propane Gas	ft	P/N	39659	39659	39659	39659	39658	39658	63003	39658	9789	9789
			Size	#58	#58	#58	#58	#56	#56	1.2mm	#56	#53	#53
	Natural Gas	7001-8000 ft	P/N	39652	39652	39652	39652	84853	84853	40414	84853	11792	11792
			Size	#50	#50	#50	#50	#47	#47	#48	#47	#41	#41
	Propane Gas	ft	P/N	95936	95936	95936	95936	39658	39658	63922	39658	9789	9789
			Size	#60	#60	#60	#60	#56	#56	1.15mm	#56	#53	#53
	Natural Gas	8001-9000 ft	P/N	39650	39650	39650	39650	40414	40414	39656	40414	11792	11792
			Size	#51	#51	#51	#51	#48	#48	#49	#48	#41	#41
	Propane Gas	ft	P/N	95936	95936	95936	95936	39658	39658	63922	39658	61652	11834
			Size	#60	#60	#60	#60	#56	#56	1.15mm	#56	1.45mm	#54

Gas Conversion Kits - Models FT and SFT

NOTE: Gas Conversion include standard burner orifices.

Model FT or SFT	30, 45, 60, 75	100, 125, 200	150	250	300
Natural to Propane Kit	179315	179317	179318	179327	179328
Propane to Natural Kit	179316	179319	179320	151180	

Optional Vertical Louvers - Models FT and SFT

Vertical louvers are designed to direct the discharge air to provide a wider throw pattern. These vertical louver option packages apply to models and sizes as listed in the table below.

The vertical louver option packages include:

Model	FT and SFT	FT	SFT	FT and SFT					
Size	30 & 45	60 & 75	60 & 75	100	125	150	200	250	300
Option Package P/N	160850	160818	160819	160820	160821	160822	160823	160824	160825
Components:	(Qty) P/N	(Qty) P/N	(Qty) P/N	(Qty) P/N	(Qty) P/N	(Qty) P/N	(Qty) P/N	(Qty) P/N	(Qty) P/N
Vertical Louver Top /Bottom Member	(2) 159443	(2) 159443	(2) 159443	(2) 159444	(2) 160889	(2) 160889	(2) 160889	(2) 160890	(2) 160890
Vertical Louver	(4) 160500	(4) 160504	(4) 160501	(6) 160501	(6) 160502	(6) 160503	(6) 160505	(10) 160503	(10) 160505
#10-16 x 1/2" lg screw	(32) 149563	(32) 149563	(32) 149563	(32) 149563	(32) 149563	(32) 149563	(32) 149563	(32) 149563	(32) 149563

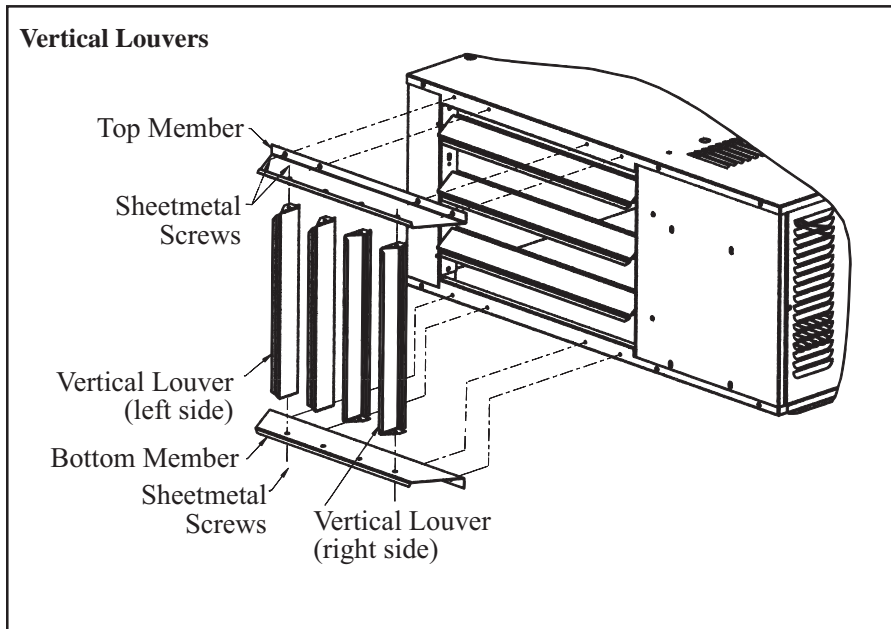

NOTE: Do not use vertical louvers above with downturn nozzle Option CD3 on page 14; vertical louvers are included in downturn nozzle Option CD4.

Optional Downturn Nozzles for Models FT and SFT 75-300

Description:

Option CD2 is a downturn nozzle with a 25-65° variable air deflection range.

Option CD3 is a downturn nozzle with a 50-90° variable air deflection range.



Option CD4 is a downturn nozzle with a 25-65° variable air deflection range and vertical louvers (same as the vertical louvers on page 13)

Option packages include:

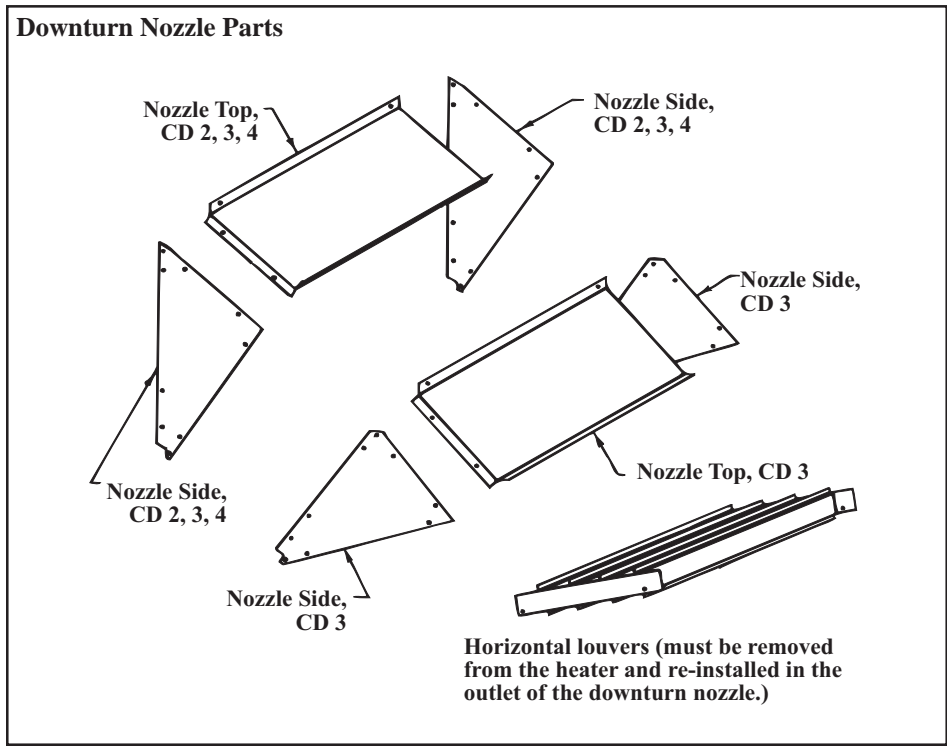
Model Size	FT		SFT		FT and SFT			
	75	75	100	125	150	200	250	300
Option CD2 Package P/N	160826	160827	160828	160829	160830	160831	160832	160833
Components:	(Qty) P/N	(Qty) P/N	(Qty) P/N	(Qty) P/N	(Qty) P/N	(Qty) P/N	(Qty) P/N	(Qty) P/N
Nozzle Side	(2) 149578	(2) 159059	(2) 159063	(2) 159060	(2) 159067	(2)159065	(2) 159067	(2) 159065
Nozzle Top	(1) 149580	(1) 149580	(1) 159062	(1) 159062	(1) 159066	(1) 159066	(1) 159068	(1) 159068
#10-16 x 1/2" lg screw	(20) 149563	(20)149563	(20) 149563	(20) 149563	(20) 149563	(20) 149563	(20) 149563	(20) 149563
Option CD3 Package P/N	160834	160835	160836	160837	160838	160839	160840	160841
Components:	(Qty) P/N	(Qty) P/N	(Qty) P/N	(Qty) P/N	(Qty) P/N	(Qty) P/N	(Qty) P/N	(Qty) P/N
Nozzle Side	(4) 149578	(4) 159059	(4) 159063	(4) 159060	(4) 159067	(4)159065	(4) 159067	(4) 159065
Nozzle Top	(2) 149580	(2) 149580	(2) 159062	(2) 159062	(2) 159066	(2) 159066	(2) 159068	(2) 159068
#10-16 x 1/2" lg screw	(34) 149563	(34)149563	(34) 149563	(34) 149563	(34) 149563	(34) 149563	(34) 149563	(34) 149563
Option CD4 Package P/N	160842	160843	160844	160845	160846	160847	160848	160849
Components:	(Qty) P/N	(Qty) P/N	(Qty) P/N	(Qty) P/N	(Qty) P/N	(Qty) P/N	(Qty) P/N	(Qty) P/N
Nozzle Side	(2) 149578	(2) 159059	(2) 159063	(2) 159060	(2) 159067	(2)159065	(2) 159067	(2) 159065
Nozzle Top	(1) 149580	(1) 149580	(1) 159062	(1) 159062	(1) 159066	(1) 159066	(1) 159068	(1) 159068
Vertical Louver Top/Bottom Member	(2) 159443	(2) 159443	(2) 159444	(2) 159444	(2) 159444	(2) 159444	(2) 159445	(2) 159445
Vertical Louver	(4) 160504	(4) 160501	(6) 160501	(6) 160502	(6) 160503	(6) 160505	(10) 160503	(10) 160505
Nozzle Angle Clip	(2) 149581	(2) 149581	(2) 159061	(2) 159061	(2) 159064	(2) 159064	(2) 159064	(2) 159064
#10-16 x 1/2" lg screw	(44) 149563	(44)149563	(44) 149563	(44) 149563	(44) 149563	(44) 149563	(44) 149563	(44) 149563



Miscellaneous - Models FT and SFT

<p>P/N 91919, Thermostat, 1-stage, 24-volt, 40-80°F (same as Option CL1)</p> 	<p>P/N 91926, Locking Cover for 1-stage thermostat (same as Option CM1)</p> 	<p>P/N 39581, Thermostat, 2-stage, 24-volt, 40-90°F (same as Option CL3)</p> 	<p>P/N 98266, High temperature tape suitable for 550°F (for vent pipe), 1" x 10 yards (same as Option FA1)</p>
---	--	--	---

